

ZAS comm.

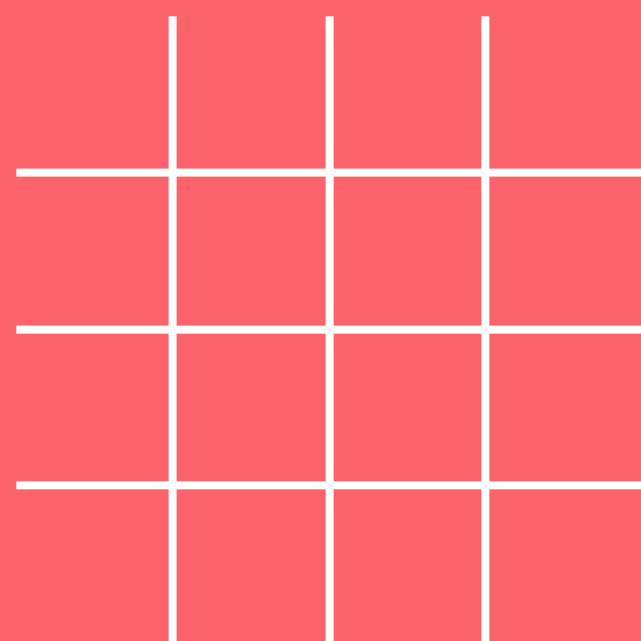

**Aim for  
excellence.**

Aiming for excellence  
reveals more opportunities.

# Introduction to Parent Company



Pharmaceuticals

**ZAS** Corporation Ltd.

Medical Devices

**ZAS** Industries Ltd.

Distribution

**ZAS** Distribution Co.

Pharma Export

**ZAS** Pharma Ltd.

Nutraceuticals

**ZAS** nutrition

Branding & Marketing Agency

**ZAS** comm.

**18+ Years**  
Serving in the  
Healthcare Sector

**500+**  
Employees

**Expertise in**  
Export, Import, Marketing  
and Distribution

**Leading in**  
Pharmaceuticals  
Products Import

# Founder's Word

---

ZAS Communications was launched in 2024 from a desire to shake up the digital marketing and content production landscape.

We believe a revolution is needed to transform how brands communicate. By prioritizing excellence, we open doors to new possibilities, encouraging a more impactful way for brands to connect with their audiences.

# Our Approach

...to Your Success



## WITH A MISSION

To provide innovative and effective integrated branding & marketing solutions that help our clients grow their businesses and realize their marketing goals.



## WITH A VISION

Delivering results-oriented branding & marketing programs and campaigns that enhance our clients' awareness, improve their sales, and foster their growth.

# More and Better

We understand that nowadays nearly every company wants MORE.



**MORE DIGITAL  
ENGAGEMENTS**



**MORE BRAND  
REPUTATION**



**MORE CUSTOMER  
ACQUISITION**

In today's digital world, businesses crave growth. They want more interaction with their audience online, a stronger brand image, and ultimately, to attract more customers. Our approach promises to deliver all three of these goals in one solution.

# Our STEP-UP Program

Let's start small. See more results.

We can develop a strategy that allows you to grow without causing you to spend more than **you're comfortable with.**

We get it.  
Most of our clients  
started "smaller".



# What We Do ...to help brands?



*World Class*  
**DIGITAL STRATEGY**



*Revolutionary*  
**CONTENT DESIGN & DEVELOPMENT**



*Result Oriented*  
**DIGITAL MARKETING**



*Interactive*  
**MOTION DESIGN & VIDEO EDITING**

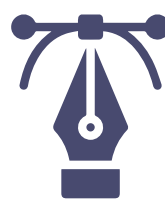

*Storytelling*  
**GRAPHIC DESIGN**



*Captivating*  
**PHOTOGRAPHY & CINEMATOGRAPHY**



*Best-in-Class*  
**WEBSITE DESIGN & DEVELOPMENT**



# How We Deliver Results

Let's unlock your brand's potential together.



**CONSULTATION  
& WORKSOP**



**CREATE &  
DEVELOP**

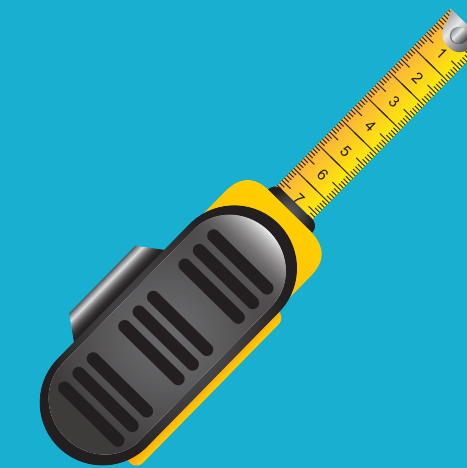

**TEST &  
MEASURE**

# OUR WORK ETHICS

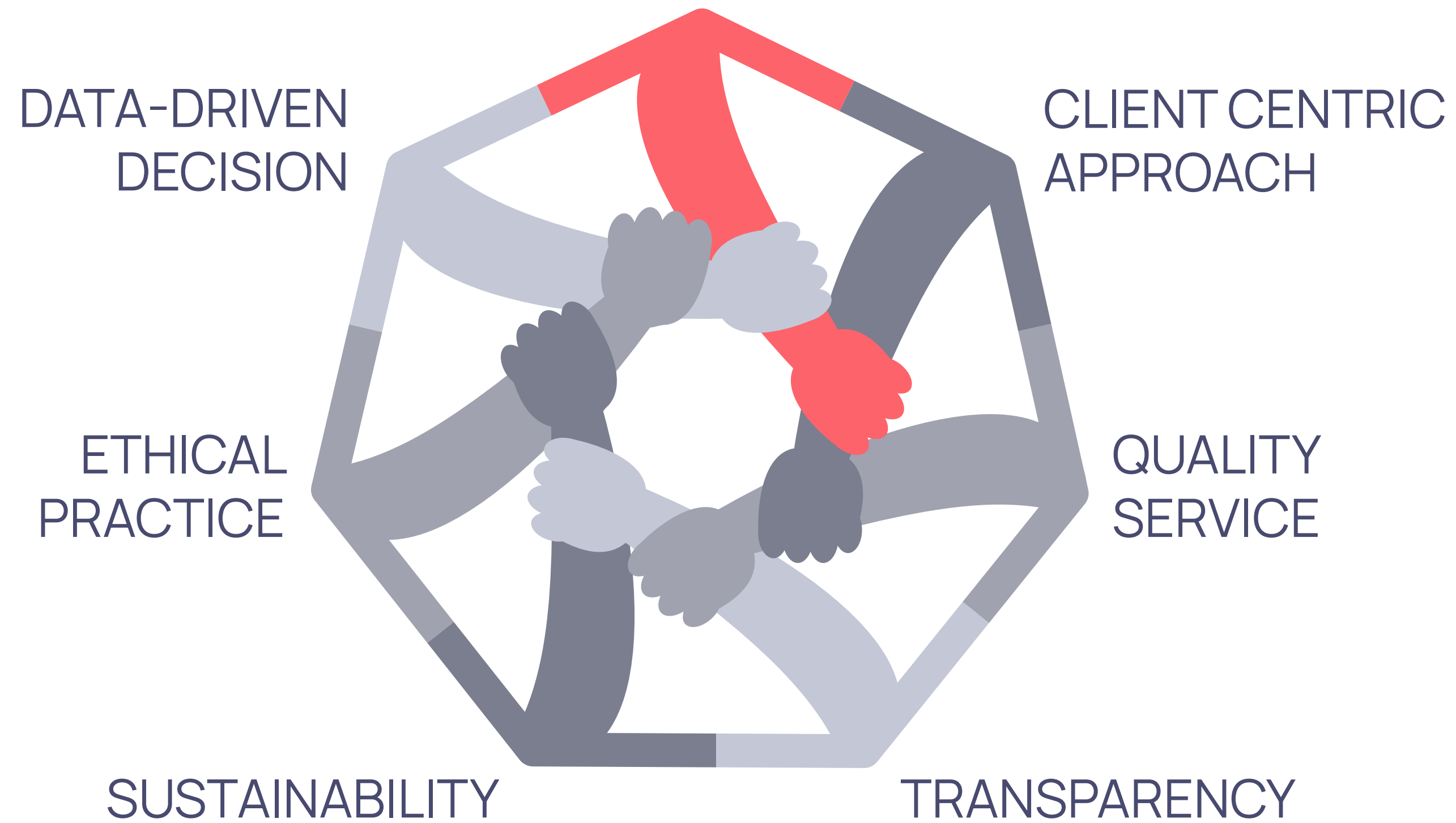

Together, let's build a brand that gets noticed.

# Our Team...looking for the best?

Look no further than our team of experts ready to tackle your challenges. We have-



**DIGITAL MARKETING &  
STRATEGY EXPERTS**



**EXPERT WEB DESIGNERS  
& DEVELOPERS**



**BRAND BUILDING EXPERTS**



**SOCIAL MEDIA EXPERTS**



**TALENTED VISUALIZERS**



**SKILLED CONTENT &  
COPYWRITERS**

# Who We Serve?

We're awesome, Just like the people we work with.



noreva

Protim $\Xi$ al<sup>®</sup>

dermalive

V-Care

**WHAT WE  
SERVE**

Project  
Showcase



SERVICE PROMOTION



SERVICE PROMOTION



SERVICE PROMOTION



TITLE: Service Promotional Content

CLIENT: Roamp (Travel Agency)

PUBLISHED: 2024

MEDIA: Social Medias



SERVICE PROMOTION



SERVICE PROMOTION



SERVICE PROMOTION



TITLE: Service Promotional Content

CLIENT: Optidot Network

PUBLISHED: 2024

MEDIA: Social Medias



PRODUCT PROMOTION

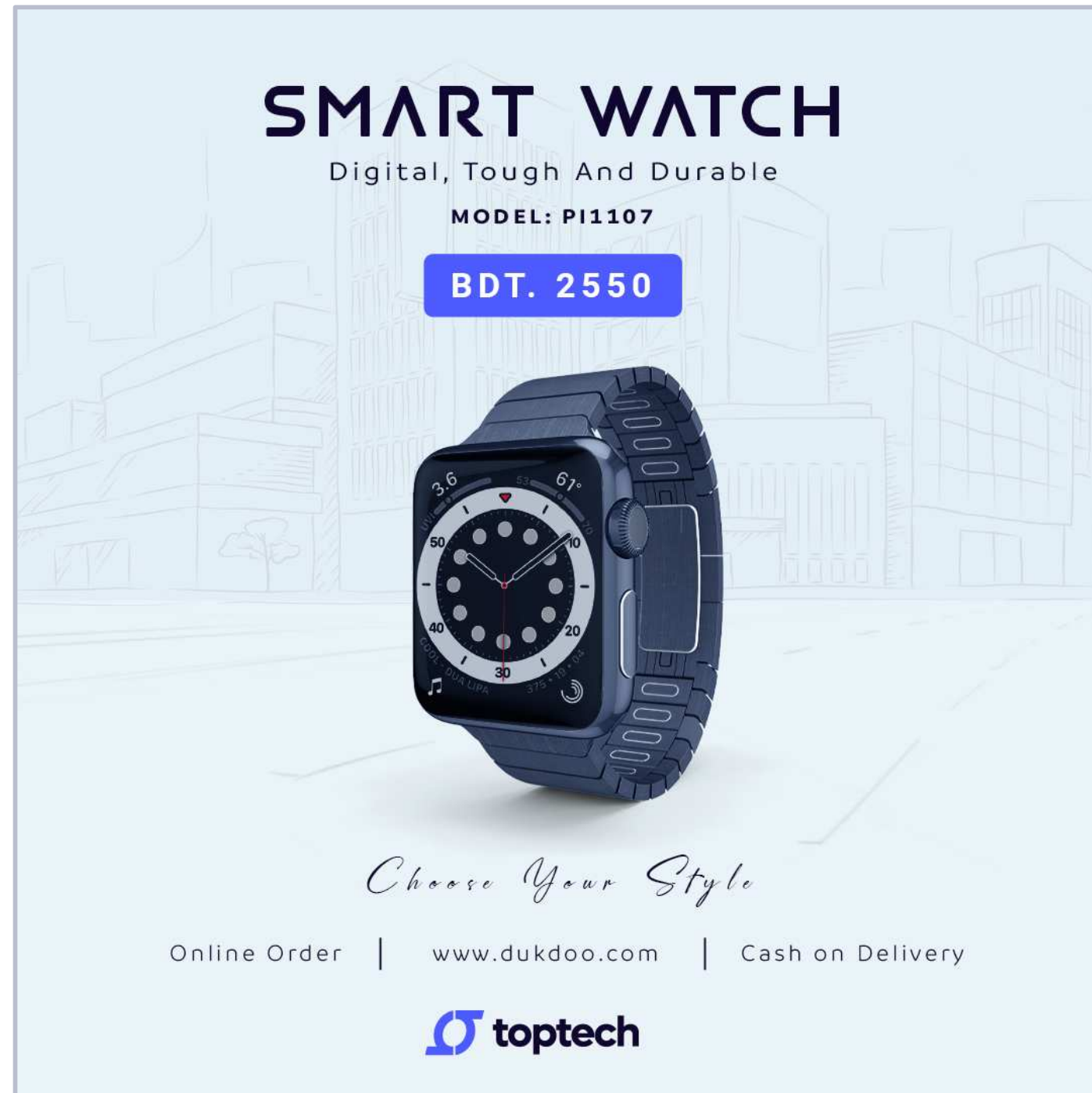

PRODUCT PROMOTION



PRODUCT PROMOTION



TITLE: Product Promotional Content

CLIENT: Toptech Technology

PUBLISHED: 2024

MEDIA: Social Medias



PRODUCT PROMOTION

PRODUCT PROMOTION

PRODUCT PROMOTION

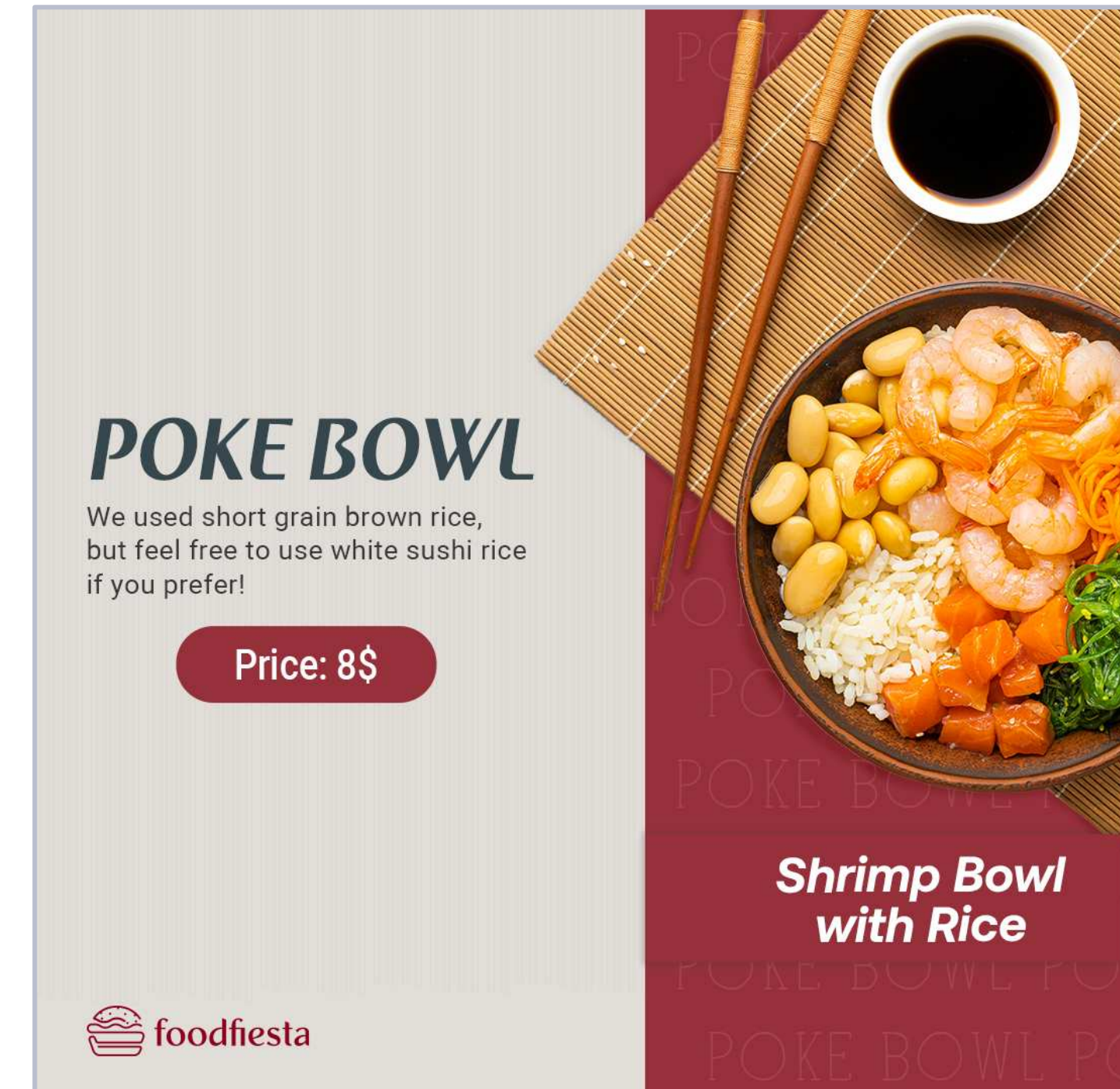
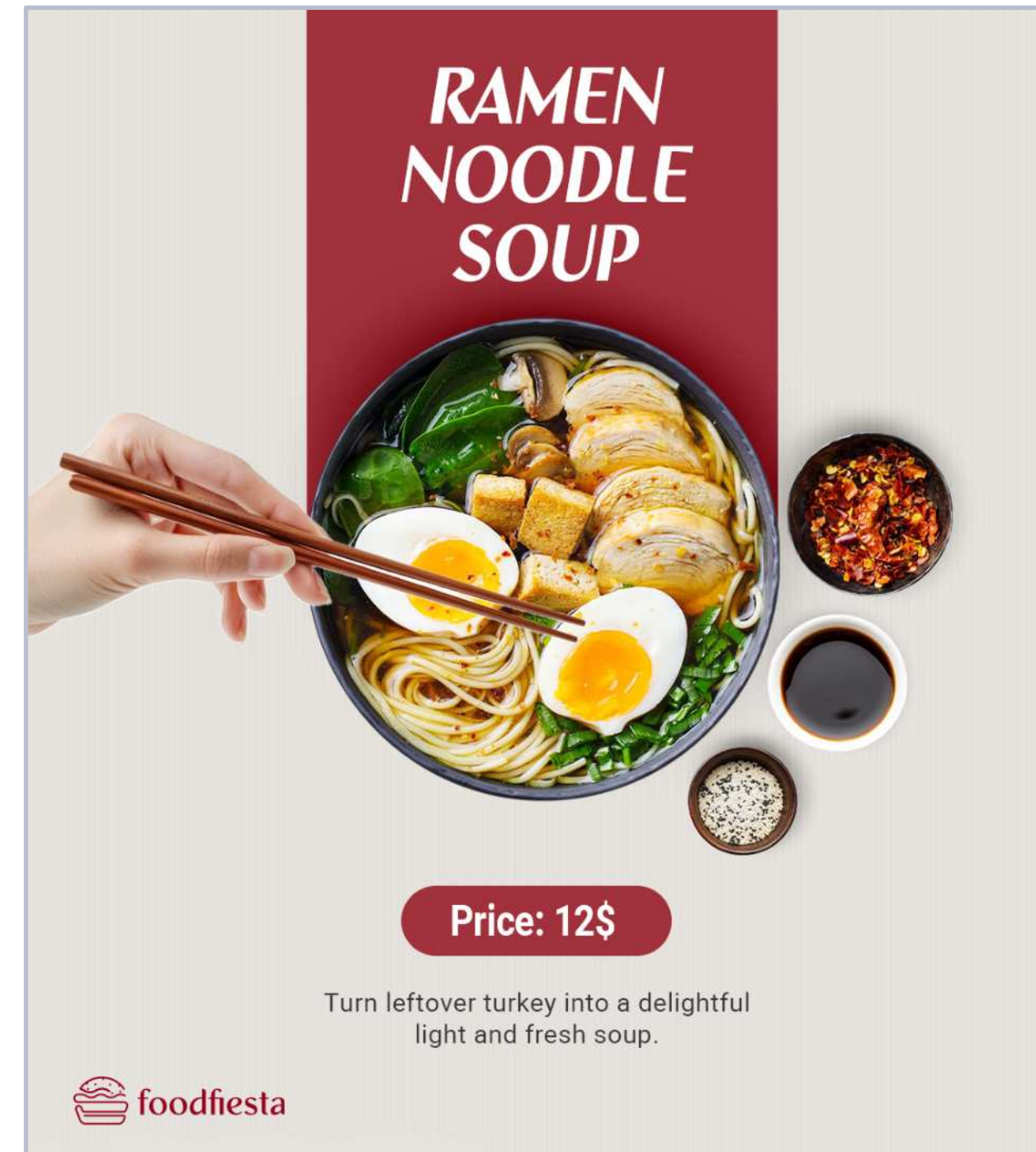
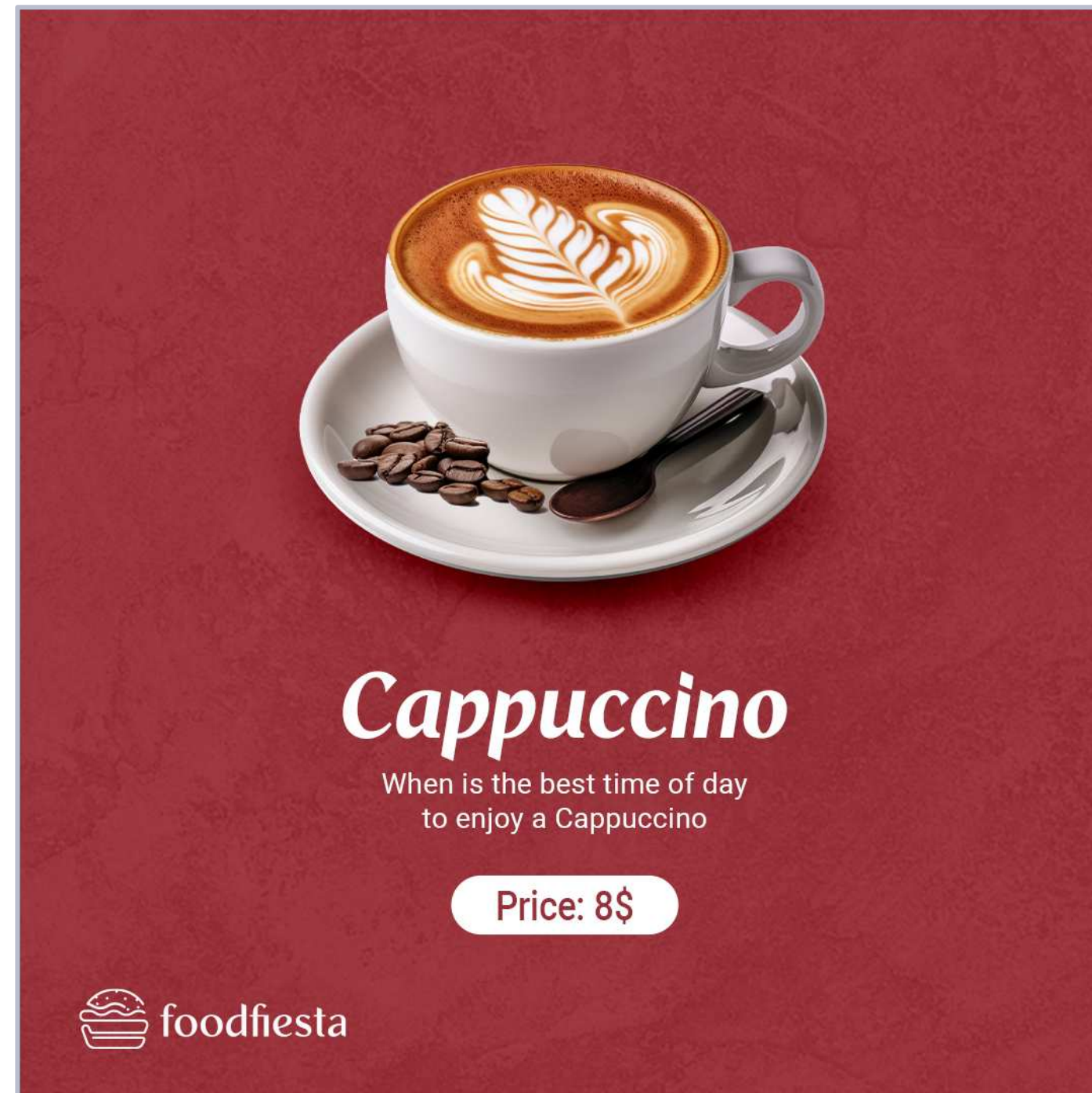

**TITLE:** Promotional Content

**CLIENT:** Foodfiesta (Restaurant)

**PUBLISHED:** 2024

**MEDIA:** Social Medias



PRODUCT PROMOTION CMAPAIGN



SERVICE PROMOTION



PRODUCT PROMOTION



TITLE: Promotional Content  
CLIENT: Addall (E-Commerce)  
PUBLISHED: 2023  
MEDIA: Social Medias



PRODUCT & SERVICE PROMOTION



PRODUCT & SERVICE PROMOTION



PRODUCT & SERVICE PROMOTION

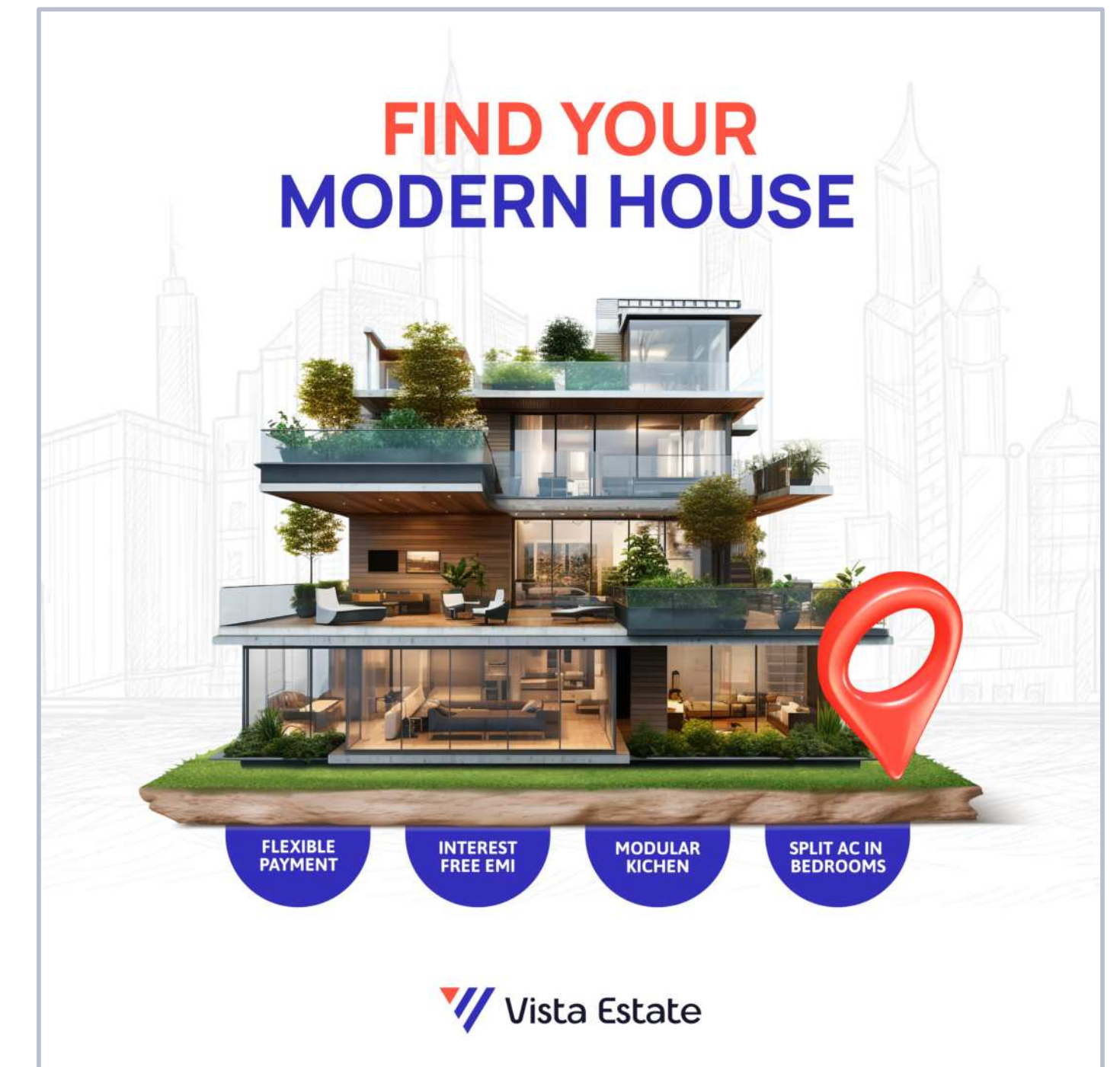

TITLE: Promotional Content

CLIENT: Vista Estate (Real Estate Company)

PUBLISHED: 2024

MEDIA: Social Medias



NEW YEAR



WINTER CAPMAIGN



MEN'S DAY



TITLE: Promotional Content

CLIENT: Oilatum Bangladesh

PUBLISHED: 2023-2024

MEDIA: Social Medias



PRODUCT PROMOTION



PRODUCT PACROMOTION



MOTHER'S DAY

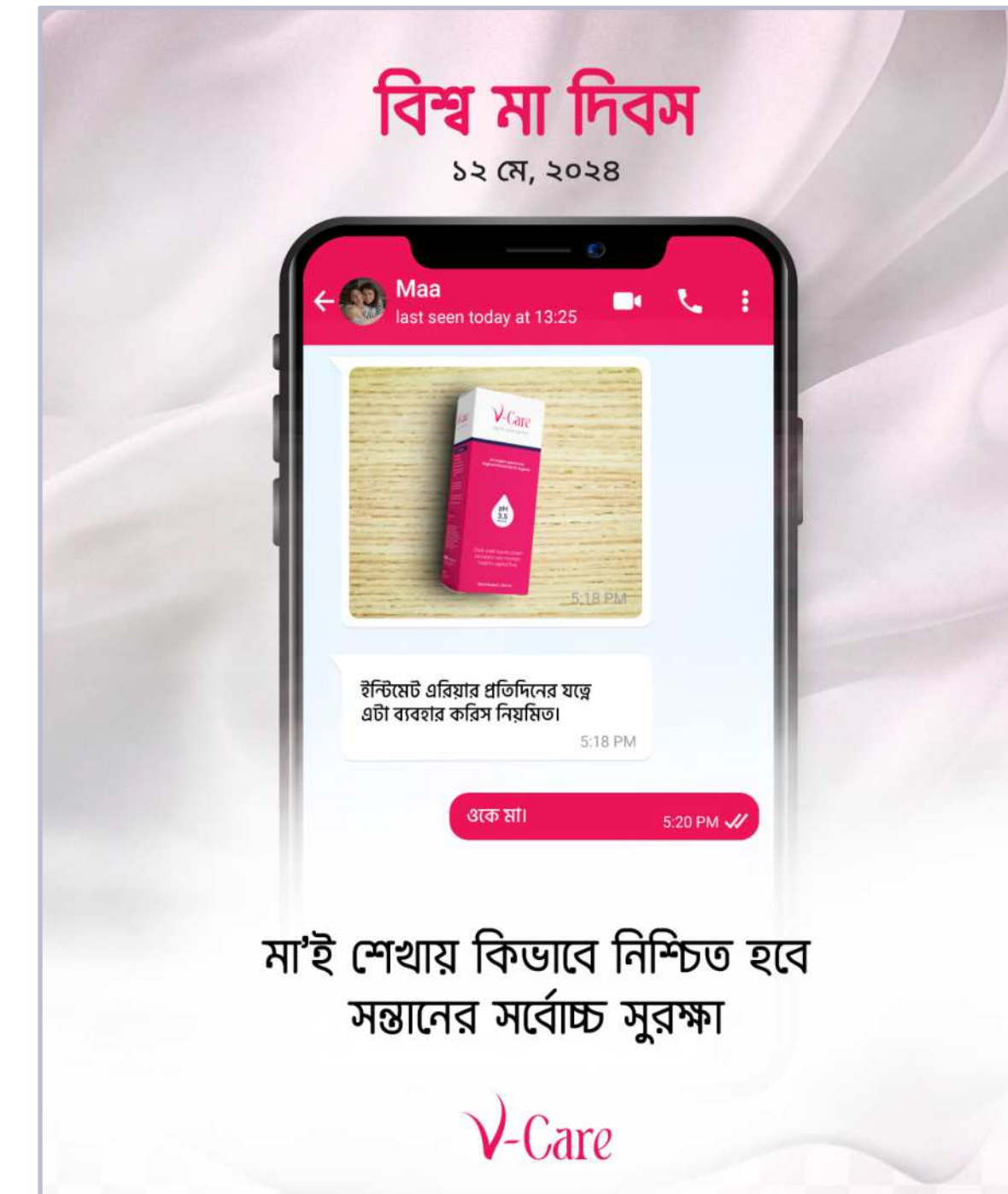

TITLE: Promotional Content

CLIENT: V-Care

PUBLISHED: 2023-2024

MEDIA: Social Medias



PRODUCT PROMOTION

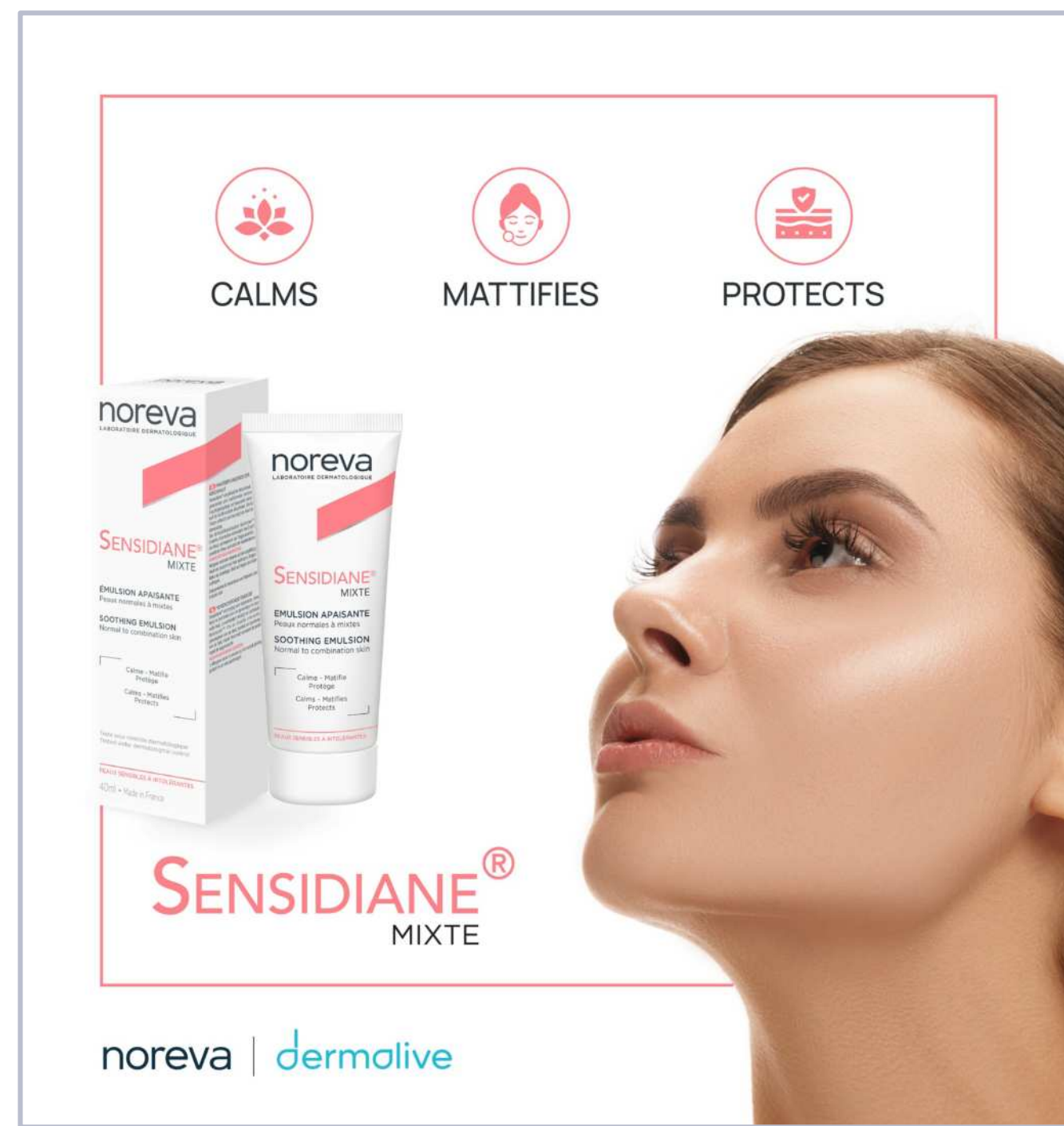

PRODUCT PROMOTION



EID CELEBRATION

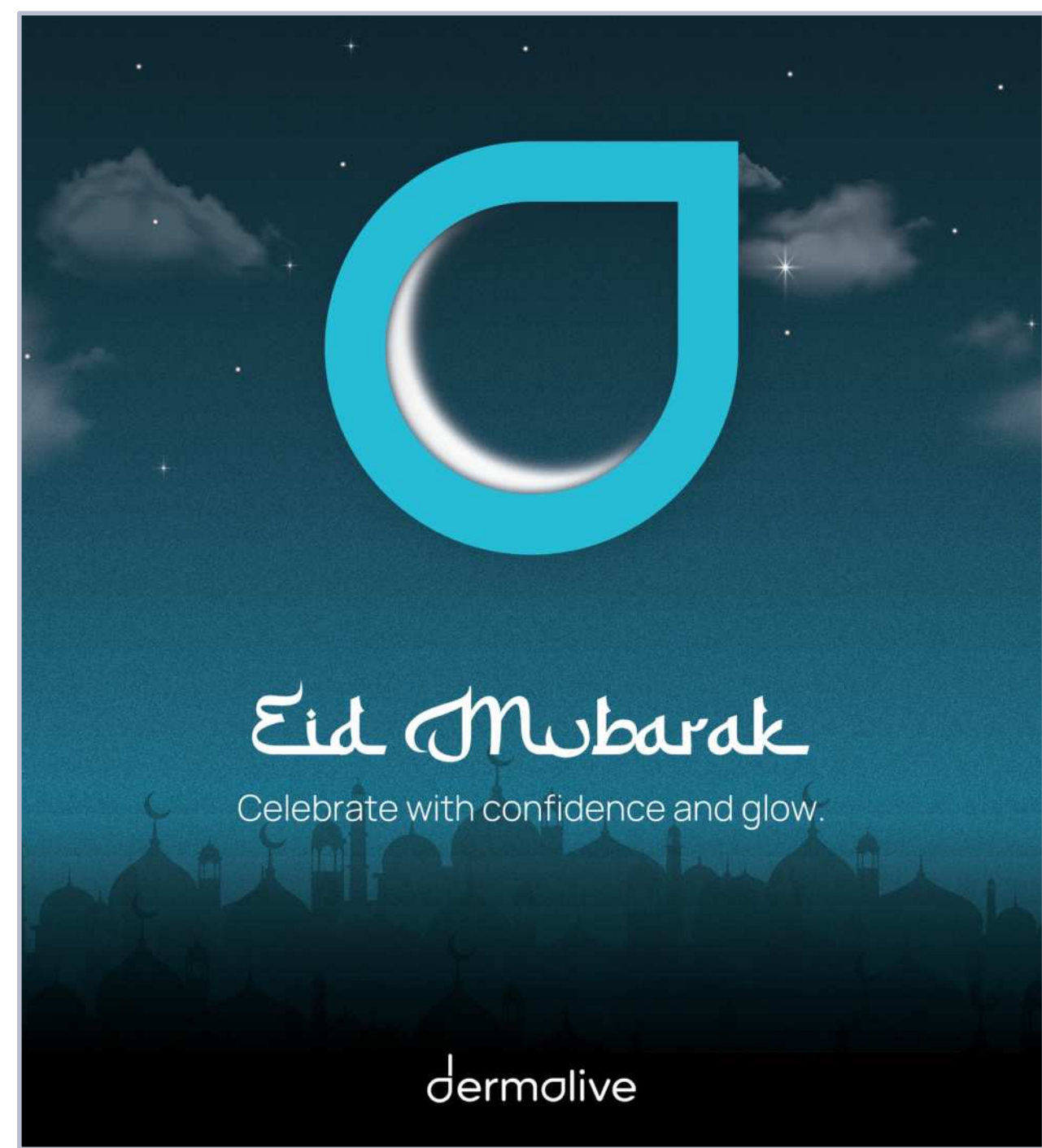

TITLE: Promotional Content

CLIENT: Noreva & Dermolive

PUBLISHED: 2024

MEDIA: Social Medias



PRODUCT PROMOTION



PRODUCT PROMOTION

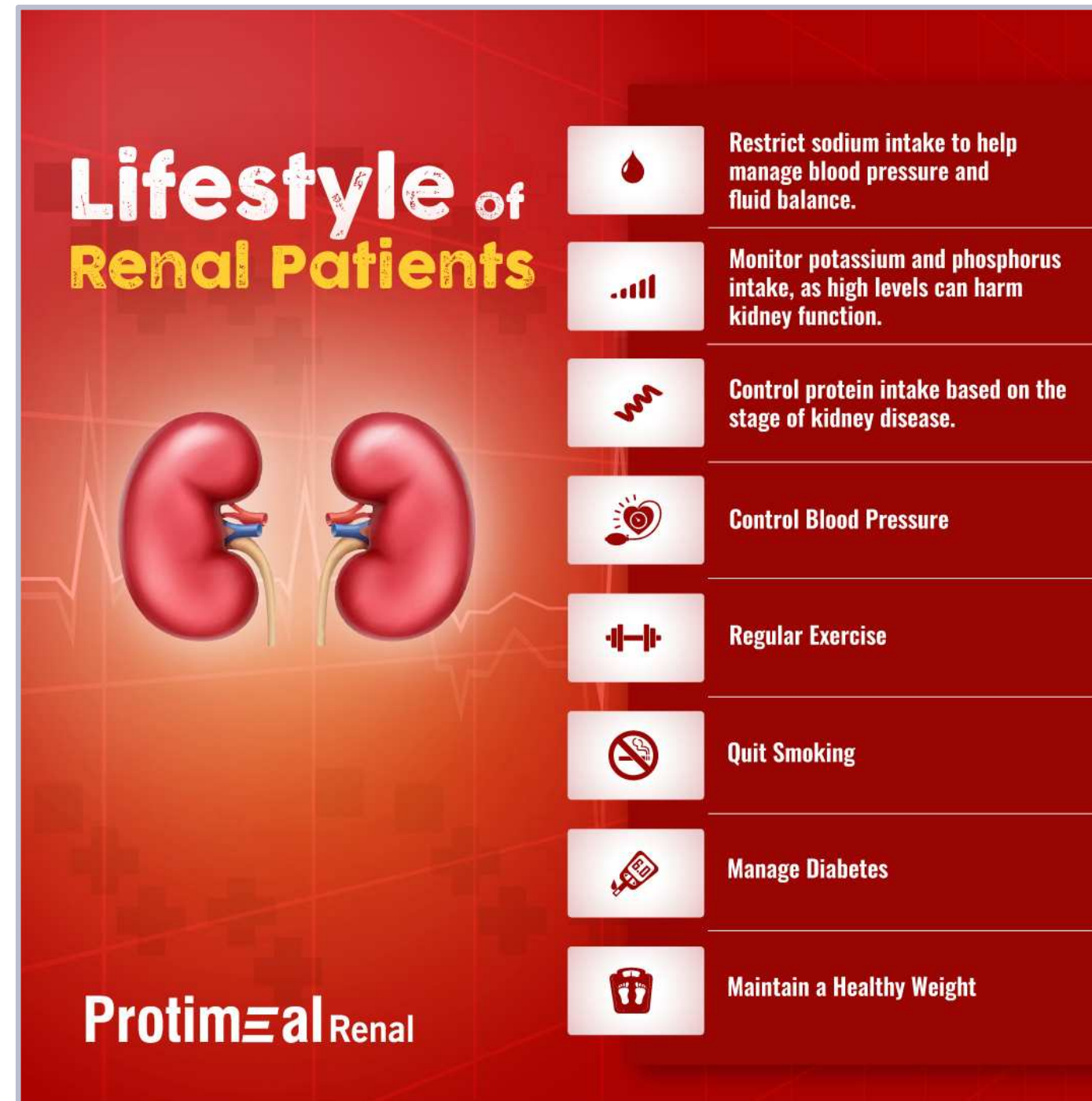

HEALTH AWARENESS



TITLE: Promotional Content

CLIENT: Protimeal

PUBLISHED: 2024

MEDIA: Social Medias



## CHILDREN'S DAY CELEBRATION



## HEALTH DAY CELEBRATION

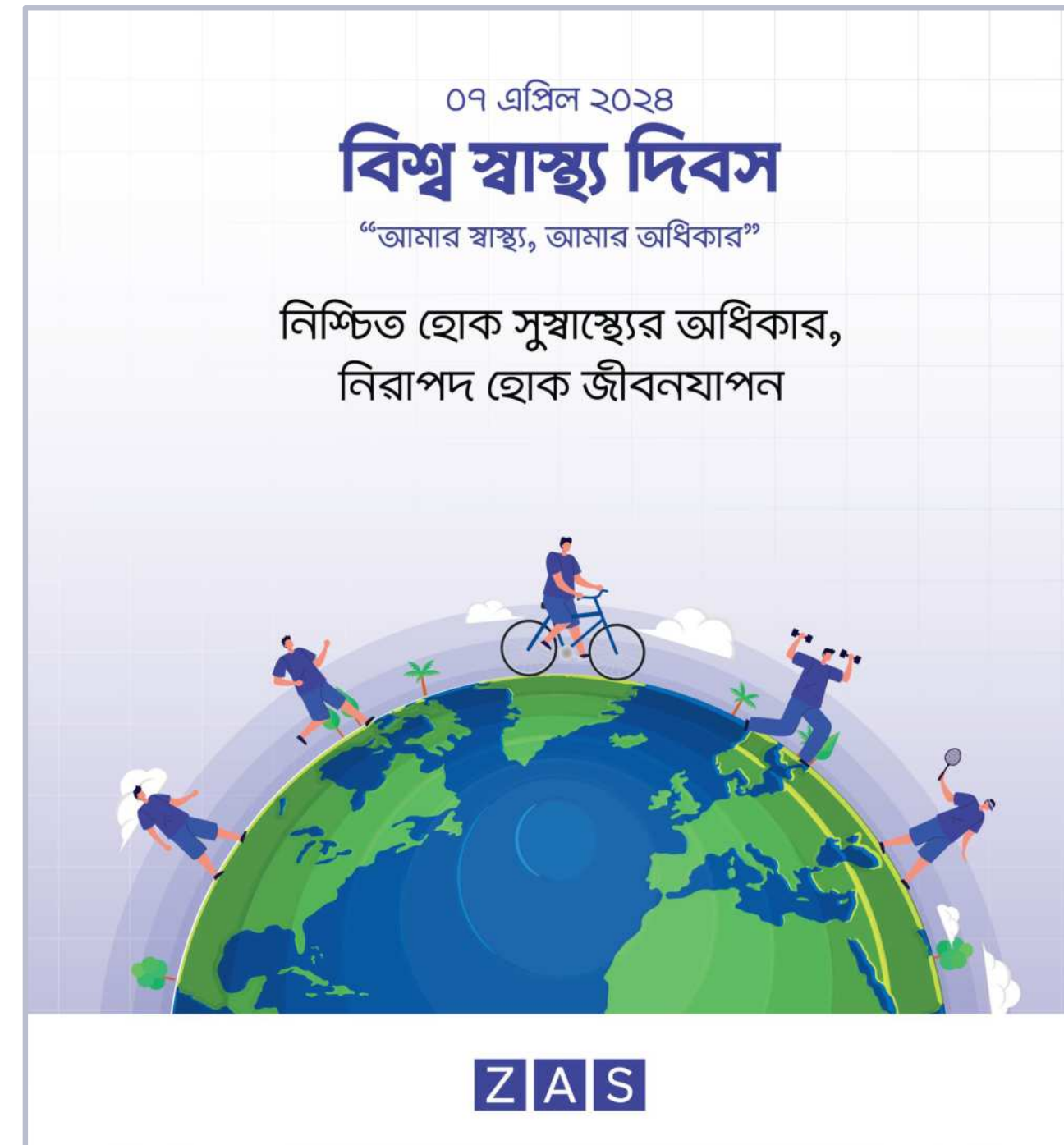

## DURGA PUJA CELEBRATION

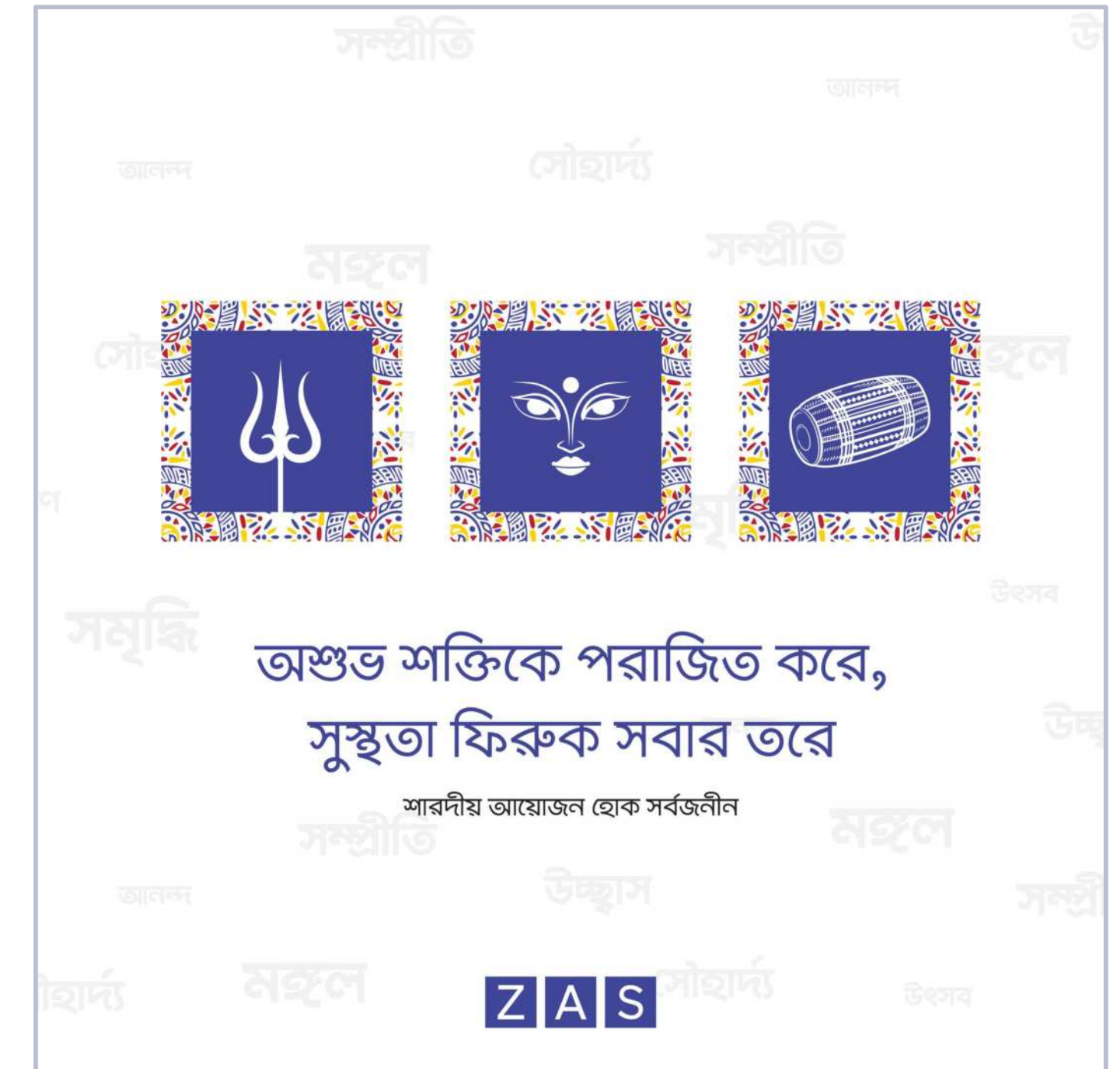

TITLE: Promotional &amp; Awareness Content

CLIENT: CLIENT: ZAS Group

PUBLISHED: 2023-2024

MEDIA: Social Medias



KIDNEY CANCER AWRARENESS

**ZAS**

16th JUNE 2022

**WORLD KIDNEY CANCER DAY**

Kidney cancer is among the 10 most common cancers in both men and women. Overall, the lifetime risk for developing kidney cancer in

1 in 80 (1.03%)	1 in 46 (2.02%)

**We are with you in this fight!**

www.zascorporation.com /zascorporation

PRODUCT PROMOTION

**Dacepton®**  
10mg/ml in 3 ml Cartridge

For the Well-Being of Parkinson's Patients

**1st TIME IN BANGLADESH**

**Dacepton 10mg/ml**  
Apomorphine hydrochloride

**D-mine Pen**

**EVER PHARMA** **ZAS**

OSTEOPOROSIS AWARENESS

**অস্টিওপোরোসিস প্রতিরোধে কী করবেন?**

<p>স্বাভাবিক দৈহিক ওজনে বজায় রাখতে হবে</p>	<p>অ্যালকোহল গ্রহণ ও ধূমপানের অভ্যাস ত্যাগ করতে হবে</p>
<p>প্রতিদিন নিয়ম মেনে এক্সারসাইজ করতে হবে</p>	<p>হাড়ের জন্য উপকারী খাদ্য গ্রহণ করতে হবে</p>

**World Osteoporosis Day**  
October 20, 2023

**BUILD BETTER BONES** | **oestrogel** 17 β ESTRADIOL | **ZAS**

TITLE: Promotional & Awareness Content

CLIENT: ZAS Group

PUBLISHED: 2023-2024

MEDIA: Social Medias



PRODUCT BROCHURE



PRODUCT BROCHURE

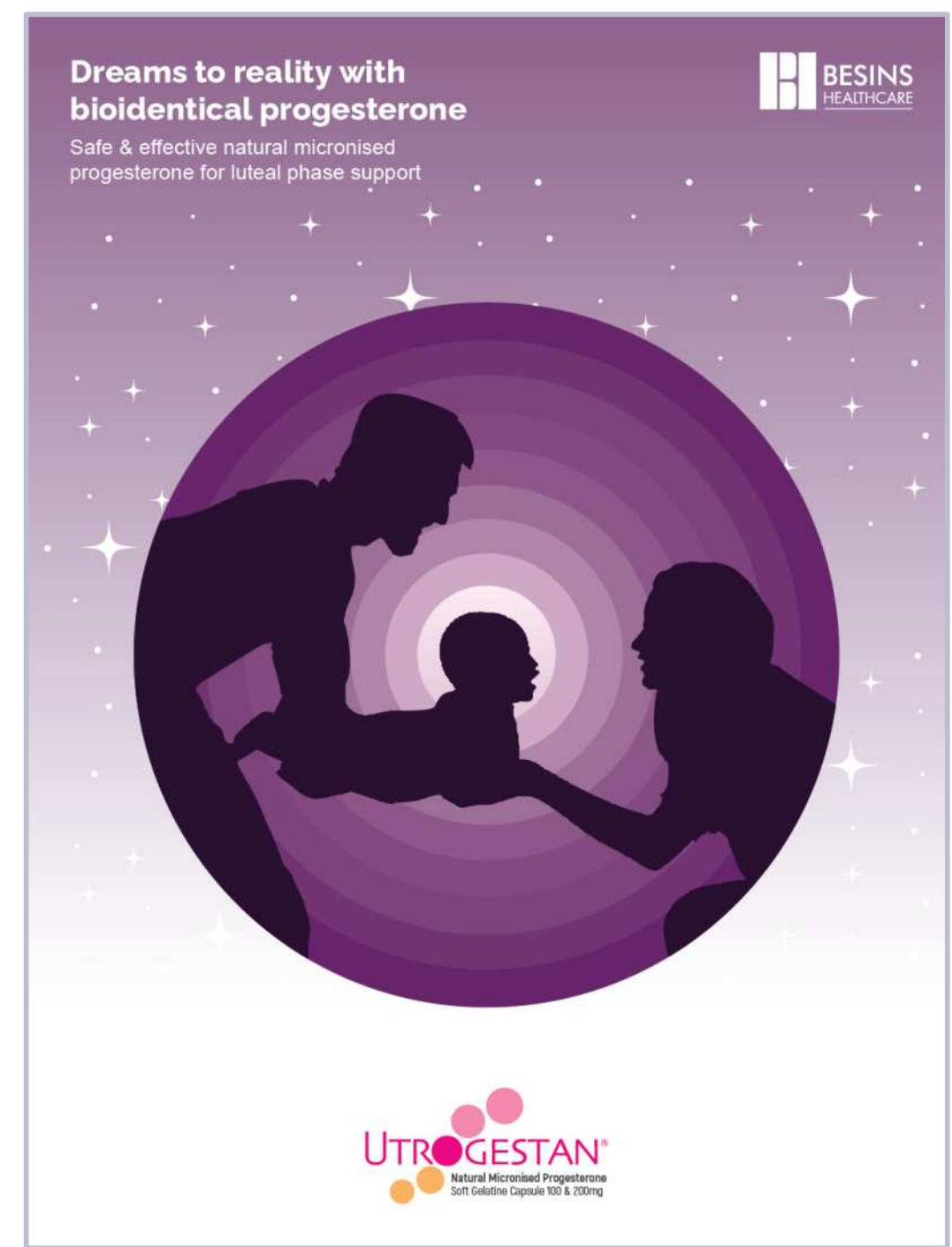

PRODUCT BROCHURE



TITLE: Marketing Materials

CLIENT: ZAS Group

PUBLISHED: 2023

MEDIA: Print & Press



CAMPAIGN CARD

**JUNE 2023 | INFERTILITY AWARENESS MONTH**

**INFERTILITY IS NOT A CURSE**

1 in 6 People Globally Affected by Infertility. (Ref: WHO)

**UTROGESTAN**  
Natural micronized progesterone  
Soft Gelatin Capsules 100 & 200mg

CAMPAIGN CARD

**Lyomark PHARMA**

**Alveofact**<sup>®</sup>  
Natural surfactant (108mg/2.4ml)  
Additives-free, Convenient therapeutic management

**IMMUNOHBs**  
Human Hepatitis B Immunoglobulin  
Only Registered HBIG in Bangladesh

**Prophylaxis of Neonates of HBsAg positive mother.**

**KEDRION BIOPHARMA**

**hameln**

**DOBUTamine hameln**  
Dobutamine hydrochloride  
250 mg in 50 ml

- No Reconstitution
- No Dilution
- Stable up to 72 hours

**COLISTIMETHATE (CMS)**  
Colistimethate Sodium 1MIU & 4.5 MIU

**LAST RESORT OF ANTIBIOTIC AGAINST GRAM-NEGATIVE MDR INFECTION.**

**xellia PHARMACEUTICALS**

TITLE: Campaign Materials

CLIENT: ZAS Group

PUBLISHED: 2023

MEDIA: Print & Press



ROLL UP BANNER

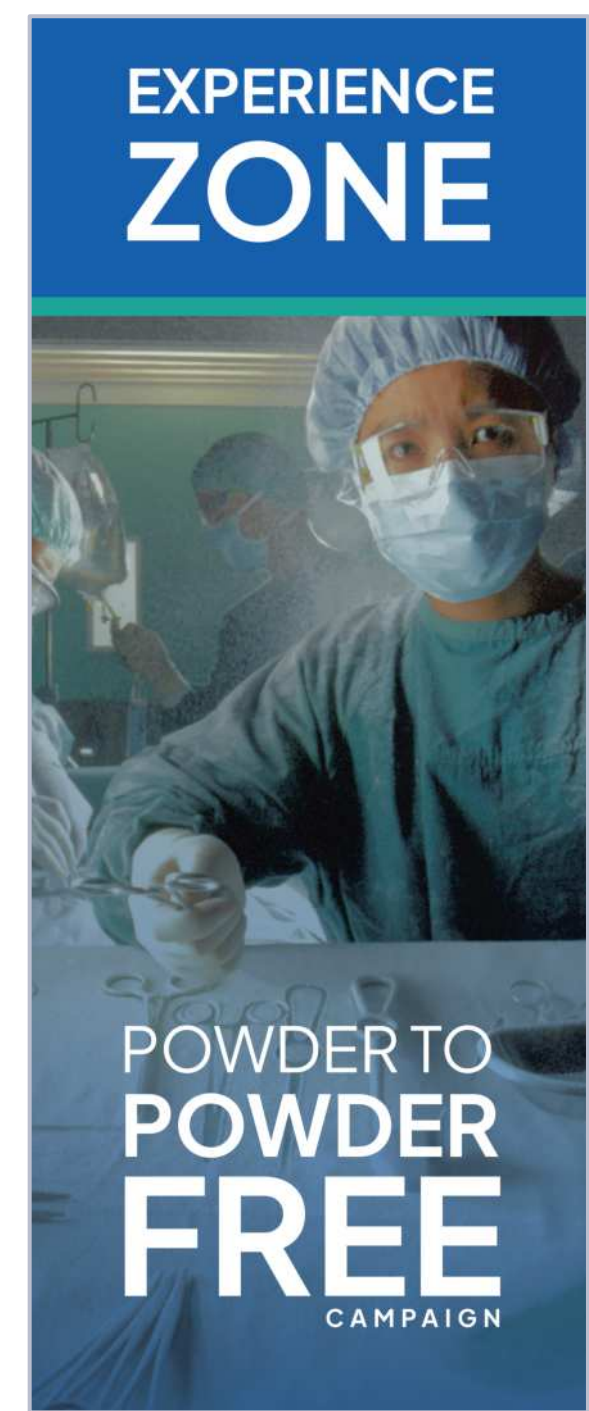

ROLL UP BANNER



ROLL UP BANNER



TITLE: Promotional Cut Out Branding

CLIENT: ZAS Group

PUBLISHED: 2023

MEDIA: Print & Press

CAMPAIGN POSTER

**জন্মগত হৃদরোগ সচেতনতা সপ্তাহ**  
৭-১৪ ফেব্রুয়ারি



**আপনি জানেন কি?**  
প্রতি ১৫ মিনিটে একটি শিশু জন্মগত হৃদরোগ নিয়ে জন্মগ্রহণ করে।  
[www.lubhp.com](http://www.lubhp.com)

**জন্মগত হৃদরোগ সচেতনতায় করণীয়ঃ**

- ▶ জন্মগত হৃদরোগ সম্পর্কে জানা
- ▶ জন্মগত হৃদরোগ নির্ণয় (নিওনেটাল স্ক্রিনিং)
- ▶ সস্তাব্য চিকিৎসা গ্রহণ
- ▶ প্রতিরোধমূলক ব্যবস্থা গ্রহণ-
  - ওজন নিয়ন্ত্রণ
  - ডায়াবেটিস নিয়ন্ত্রণ
  - পুষ্পান পরিহার
  - গর্ভাবস্থায় বিশেষজ্ঞ চিকিৎসকের পরামর্শ বিহীন ঔষধ সেবন থেকে বিরত থাকা

**ছোট হৃদয় বড় প্রত্যাশা বহন করে**

সমর্থনেঃ **CDC** CENTERS FOR DISEASE CONTROL AND PREVENTION

সচেতনতায়ঃ **ZAS**

সৌজন্যেঃ **UTROGESTAN** | গর্ভাবস্থায় মা ও শিশুর জন্য একমাত্র নিরাপদ প্রজেক্টরেন

CAMPAIGN POSTER

**গর্ভাবস্থায় হেপাটাইটিস-বি এবং করণীয়**

**গর্ভাবস্থার শুরুতে অবশ্যই হেপাটাইটিস-বি পরীক্ষা করে নিন**

**আপনার পরিবারের সদস্যদের এবং স্বামী/স্ত্রীর হেপাটাইটিস-বি পরীক্ষা করুন।**  
যদি পূর্বে তাদের হেপাটাইটিস-বি ডাকচিট্রন দেয়া না হলে তখন পূর্বে শীঘ্রই তাদের হেপাটাইটিস-বি ডাকচিট্রন এর চিকিৎসা পূর্ণ করতে হবে এবং যদি তারা হেপাটাইটিস-বি তে আক্রান্ত হয়ে যায় তাহলে চিকিৎসকের পরামর্শ নিয়ে চিকিৎসা শুরু করতে হবে।

**চিকিৎসকের পরামর্শ অনুযায়ী পরবর্তী চিকিৎসা শুরু করুন**  
WHO এর গাইডলাইন অনুযায়ী বৃদ্ধি কমানোর জন্য গর্ভবতী মা-কে 3rd ট্রাইমস্টার Antiviral চিকিৎসা নিতে হবে।

**জন্মের পরে**  
জন্মের পরজন্মের পরে জন্মের পর ১২ ঘণ্টার মধ্যে HBeAg এর মান নির্ণয় করে হেপাটাইটিস-বি এর ১ম ডোজ টিকা দিন। (১)

**১-২ মাস**  
জন্মের পরজন্মের পরে হেপাটাইটিস-বি এর ২ম ডোজ টিকা দিন। (২)

**৬ মাস**  
জন্মের পরজন্মের পরে হেপাটাইটিস-বি এর ৩য় ডোজ টিকা দিন। (৩)

**মাতৃদুহ্ন**  
নবজাতকের জন্য মাতৃদুহ্ন বিলাস কিছুই নেই।  
WHO এর মতে, হেপাটাইটিস-বি হেপাটাইটিস-বি পরীক্ষা করে নিন এবং নবজাতকের সিকিৎসা শুরু করে নিন।  
হেপাটাইটিস-বি মাতৃদুহ্ন হ্রাস করার জন্য হেপাটাইটিস-বি সিকিৎসা শুরু করে নিন এবং নবজাতকের সিকিৎসা শুরু করে নিন।

**জন্মস্বার্থেঃ**  
**NOhep**

**IMMUNOHBS<sup>®</sup>**  
Hepatitis B Immunoglobulin

১) মাতৃদুহ্ন হ্রাস করার জন্য হেপাটাইটিস-বি টিকা এর চিকিৎসা ১ বছরের মধ্যে শুরু করতে হবে।  
২) হেপাটাইটিস-বি পরীক্ষা করে নিন এবং নবজাতকের সিকিৎসা শুরু করে নিন।  
৩) হেপাটাইটিস-বি টিকা এর চিকিৎসা শুরু করে নিন এবং হেপাটাইটিস-বি টিকা এর চিকিৎসা শুরু করে নিন।

TITLE: Branding & Promotion

CLIENT: ZAS Group

PUBLISHED: 2023

MEDIA: Print & Press



Brand Mark



Development Process

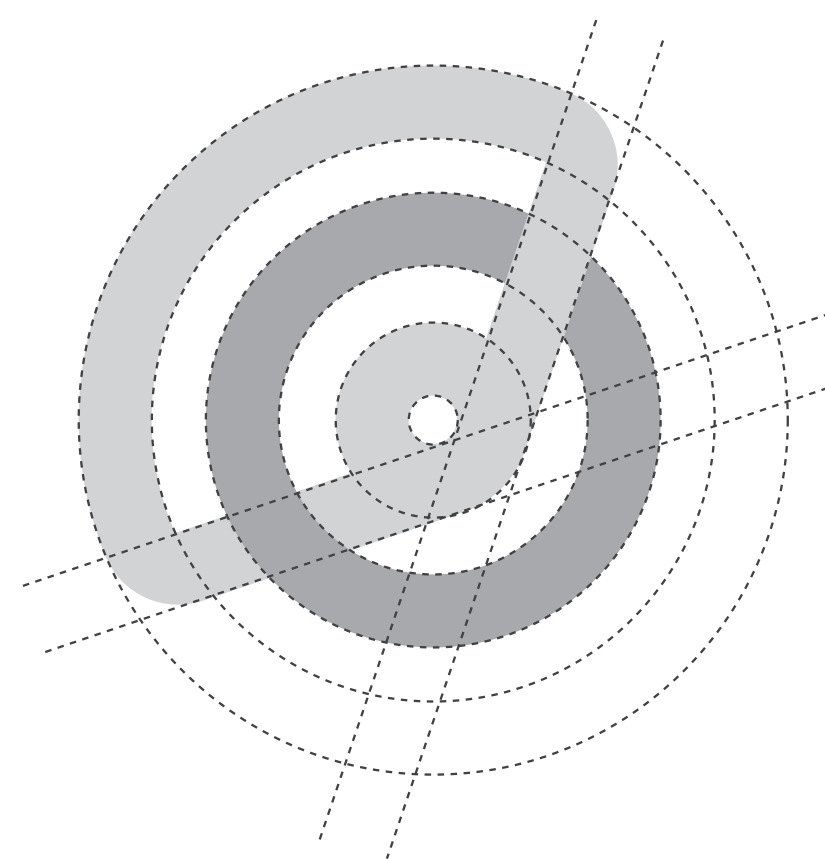

Color Palletes



Logo Meaning



Connection of Letter "O"  
and Wifi Signal



The Green Dot Mean  
A Connection to Precision

App Icon



Brand Mark



Development Process

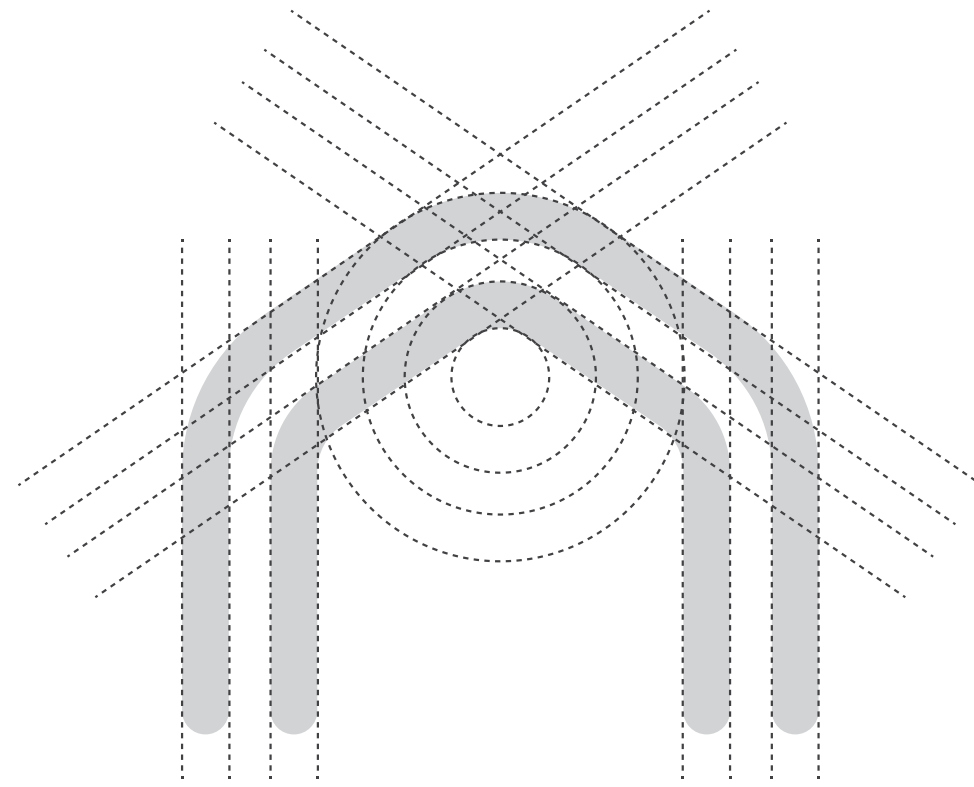

Color Palletes



Logo Meaning



Connection of Letter "A"  
and Price Tag



Reflection Two Letter "A"  
One for Add, Another for All

App Icon



Brand Mark

dermalive

Development Process

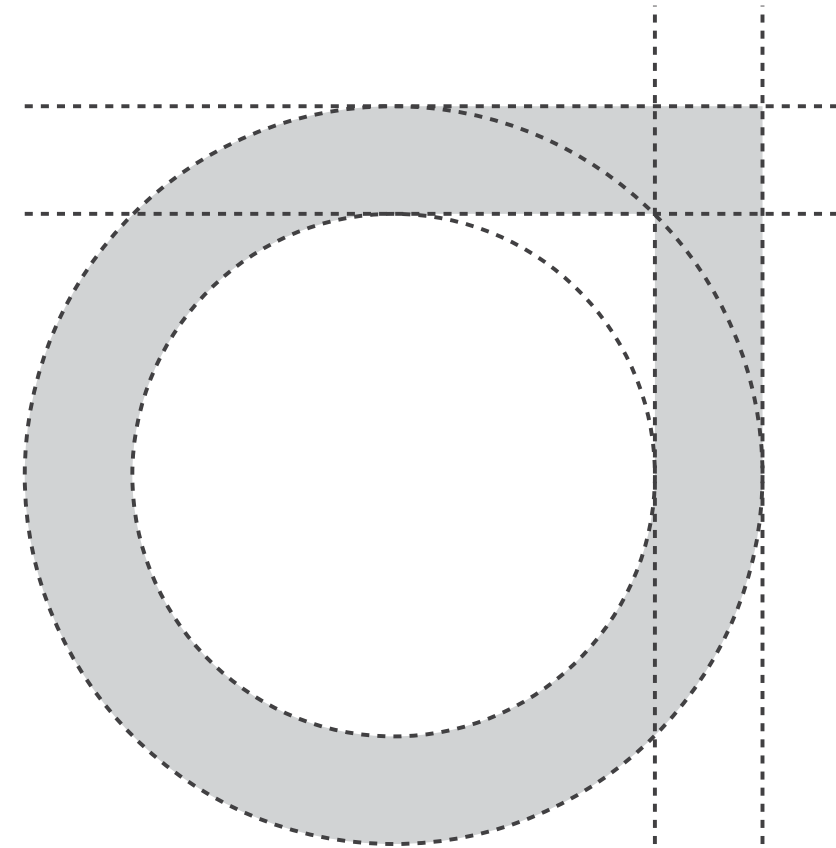

Color Palletes

#23bad5

#0b5668

Logo Meaning

dermalive

Letter "d"

dermalive

Water Drop to Relefection  
of Skin Care Product

Logo Icon





Brand Mark



Development Process



Color Palletes

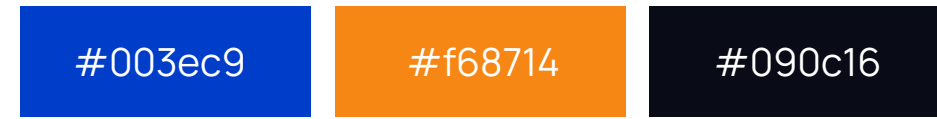

Logo Meaning



A Symbol of  
Letter "R"



Reflection of Airplane Symbol  
to Present Travelling

App Icon



Brand Mark



Development Process

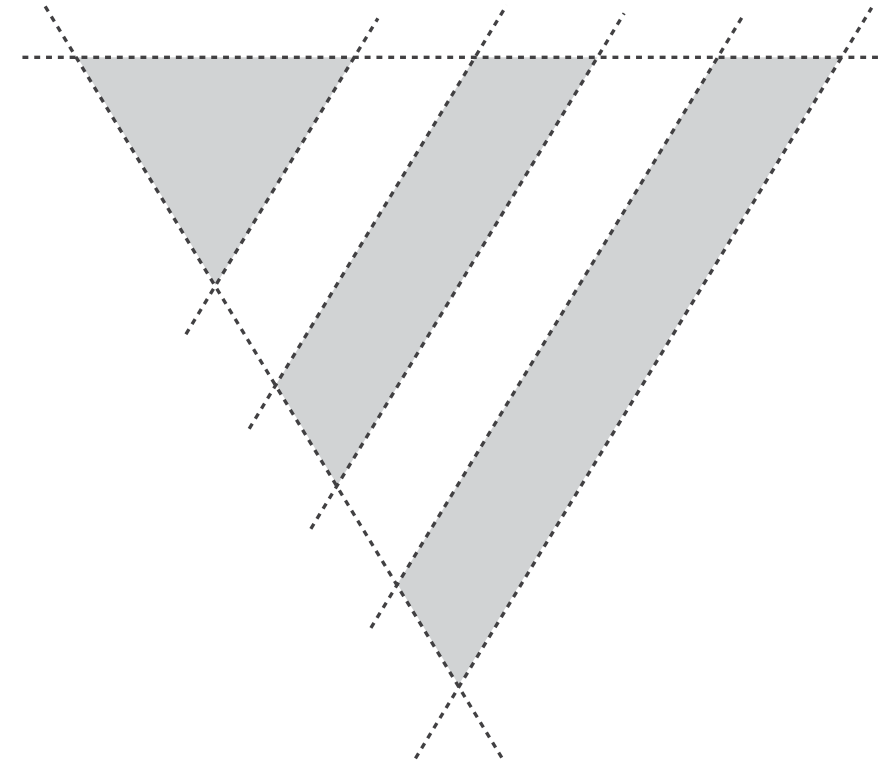

Color Palletes



Logo Meaning



A Symbol of Letter  
"V & E" Together



Abstract Arrow Shapes Carries The  
Meaning of Strong Architecture

App Icon



Brand Mark



Development Process

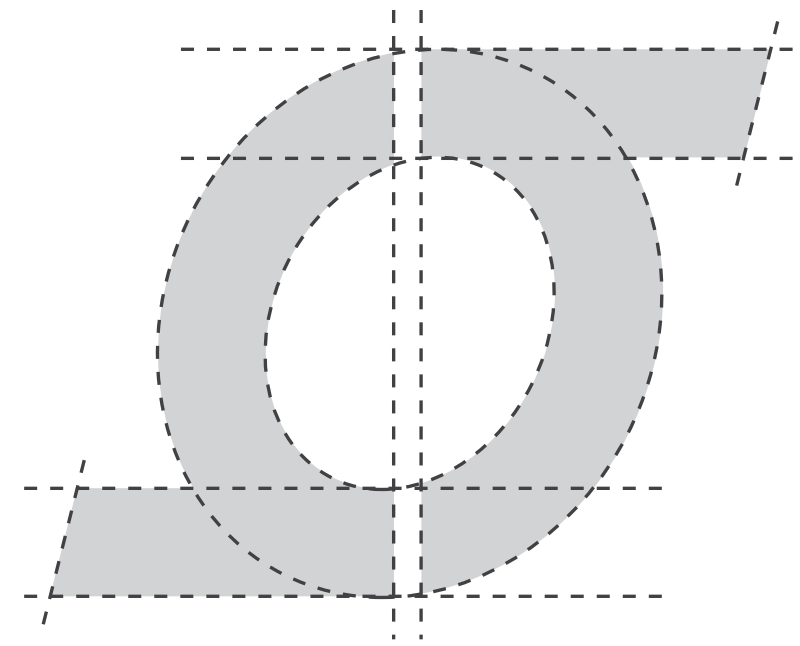

Color Palletes

#4d5bff

#100730

Logo Meaning



A Symbol of Letter  
"T & T" Together

App Icon



Brand Mark



Color Palette

#8d021f

Logo Meaning



A Symbol Some  
Foods Together

App Icon



WEBSITE DESIGN

# FEATURED WORKS

TITLE: Website Design

CLIENT: ZAS Pharma Ltd.

PUBLISHED: 2023

DOMAIN: www.zaspharma.com.bd

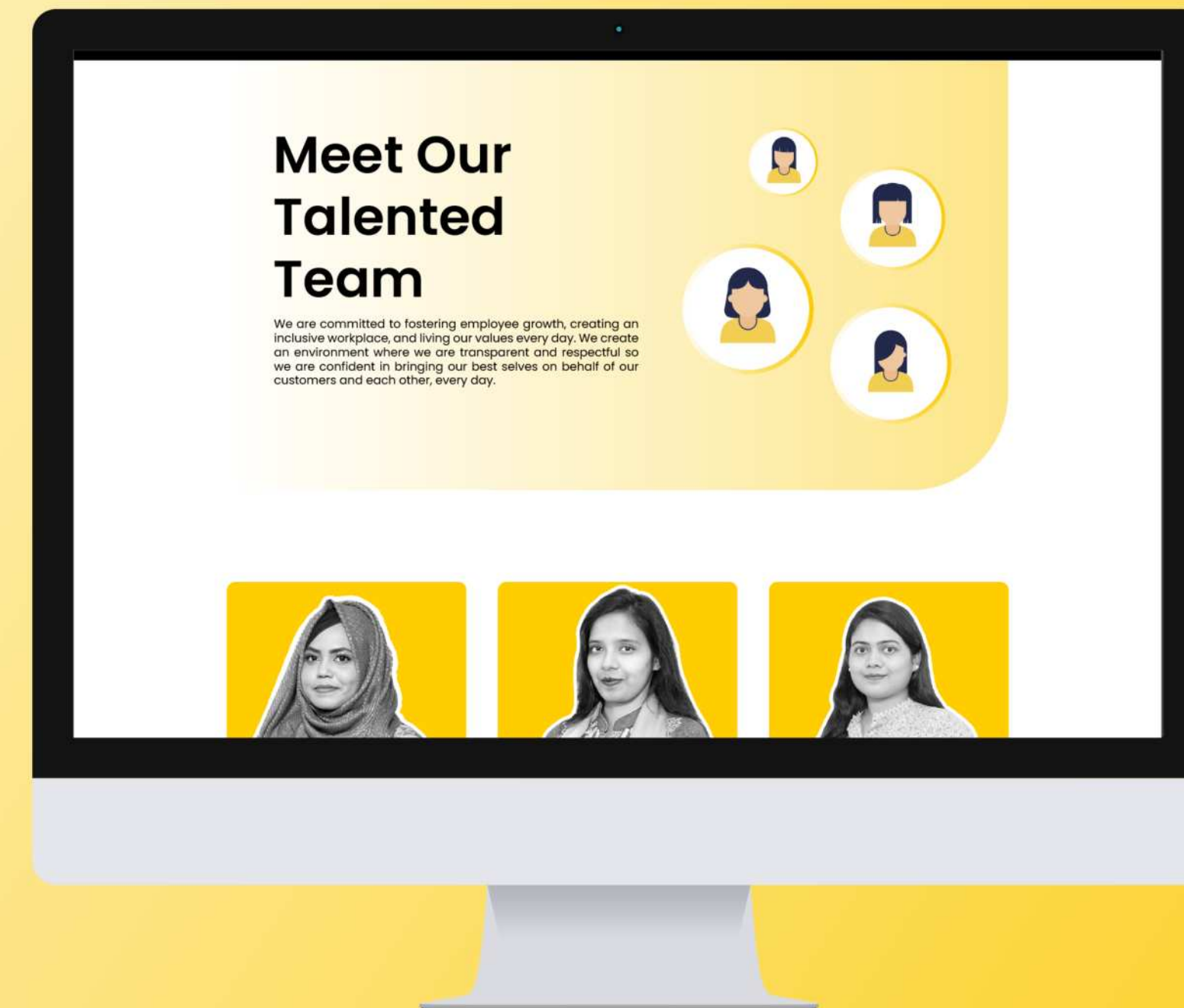
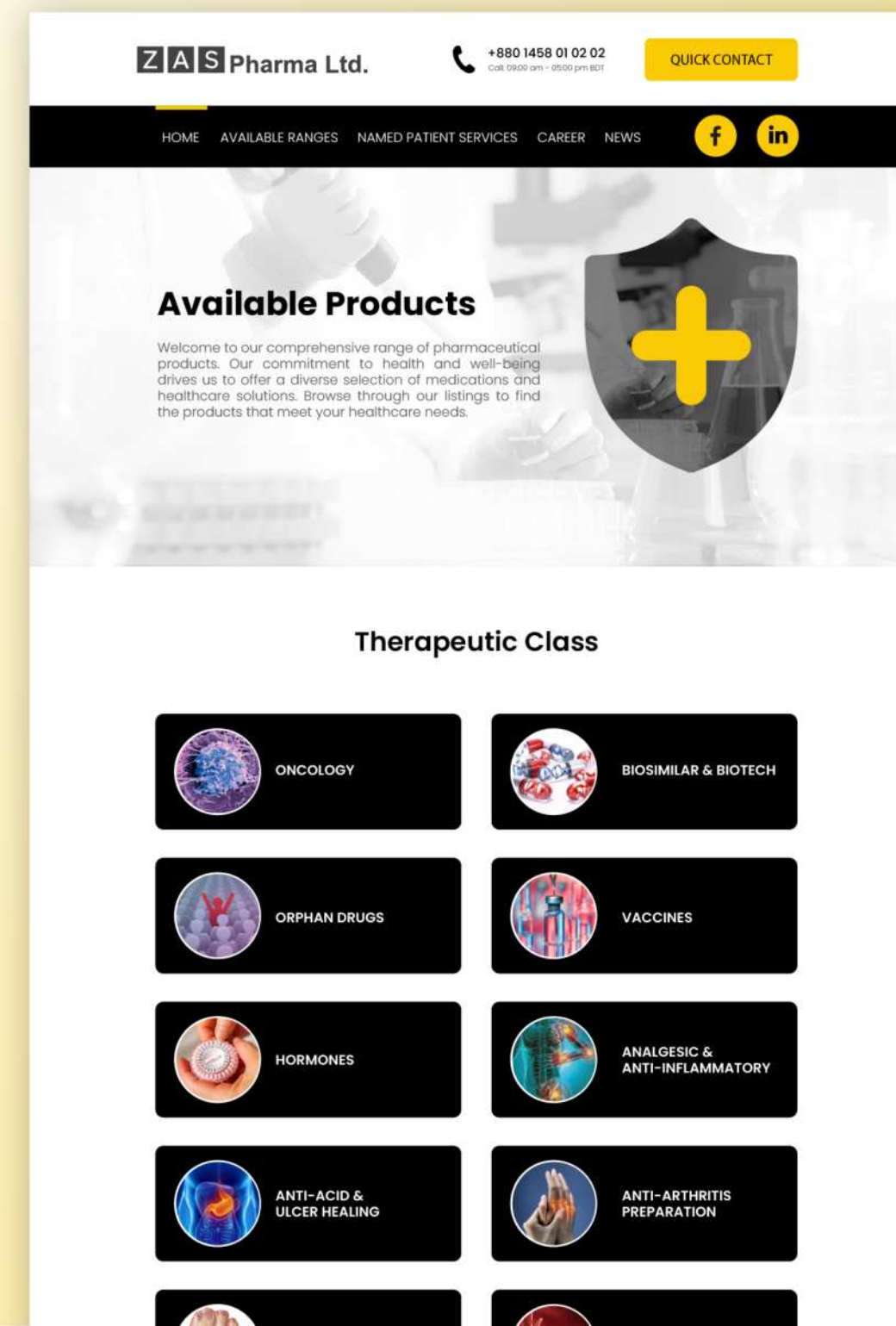
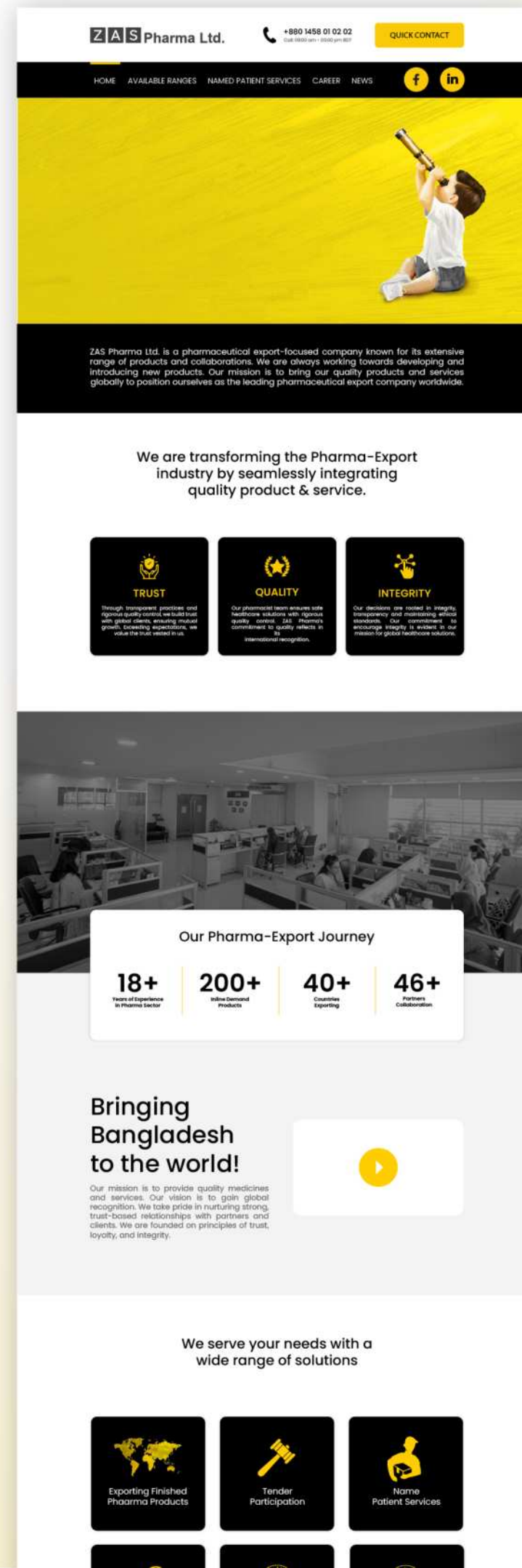



WEBSITE DESIGN

# FEATURED WORKS

TITLE: Website Design

CLIENT: Pharma Parts Corp.

PUBLISHED: 2024

DOMAIN: parmapartscorp.com

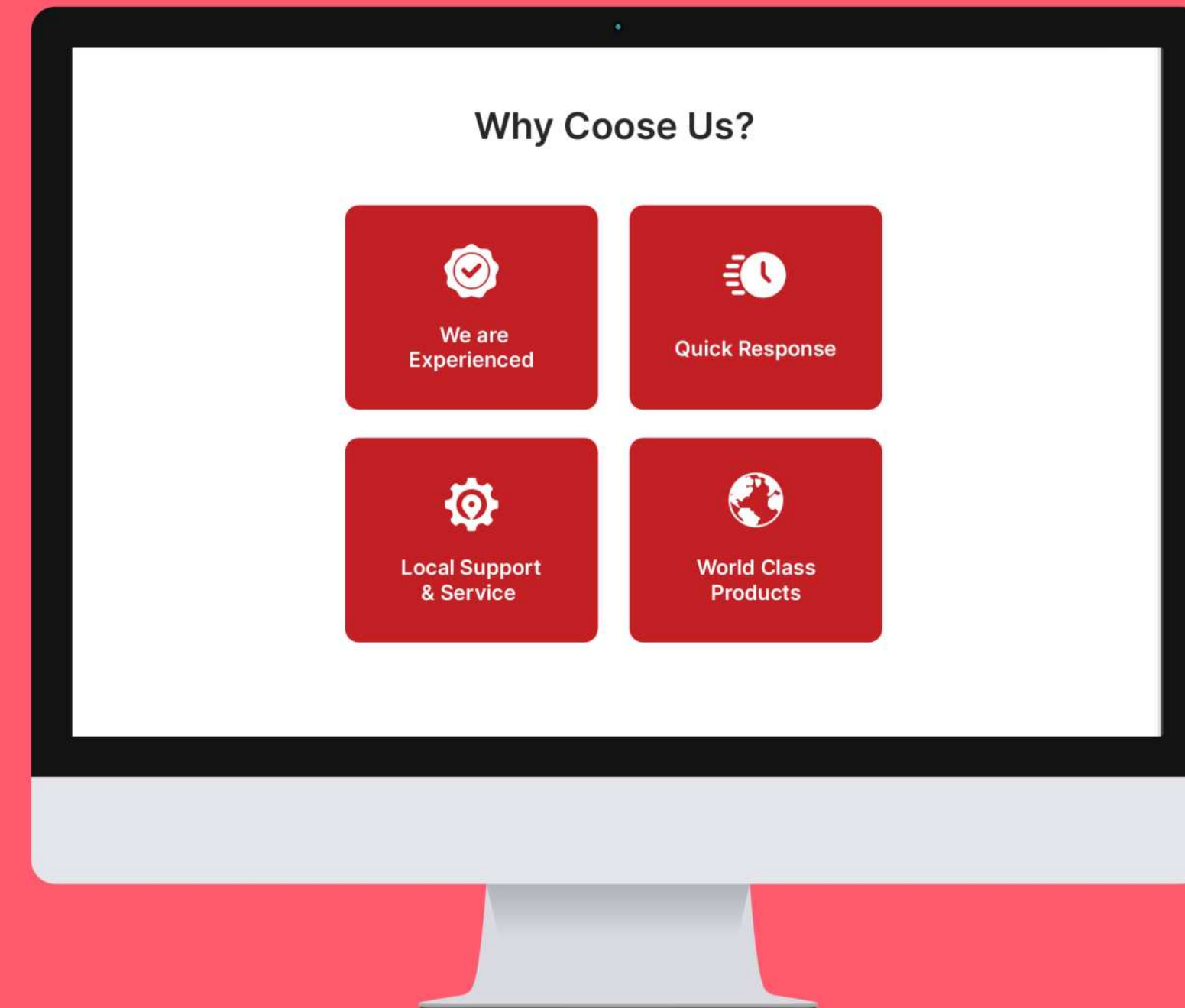

WEBSITE DESIGN

# FEATURED WORKS

TITLE: Website Design

CLIENT: ZAS Corporation

PUBLISHED: 2024

DOMAIN: zascorporation.com

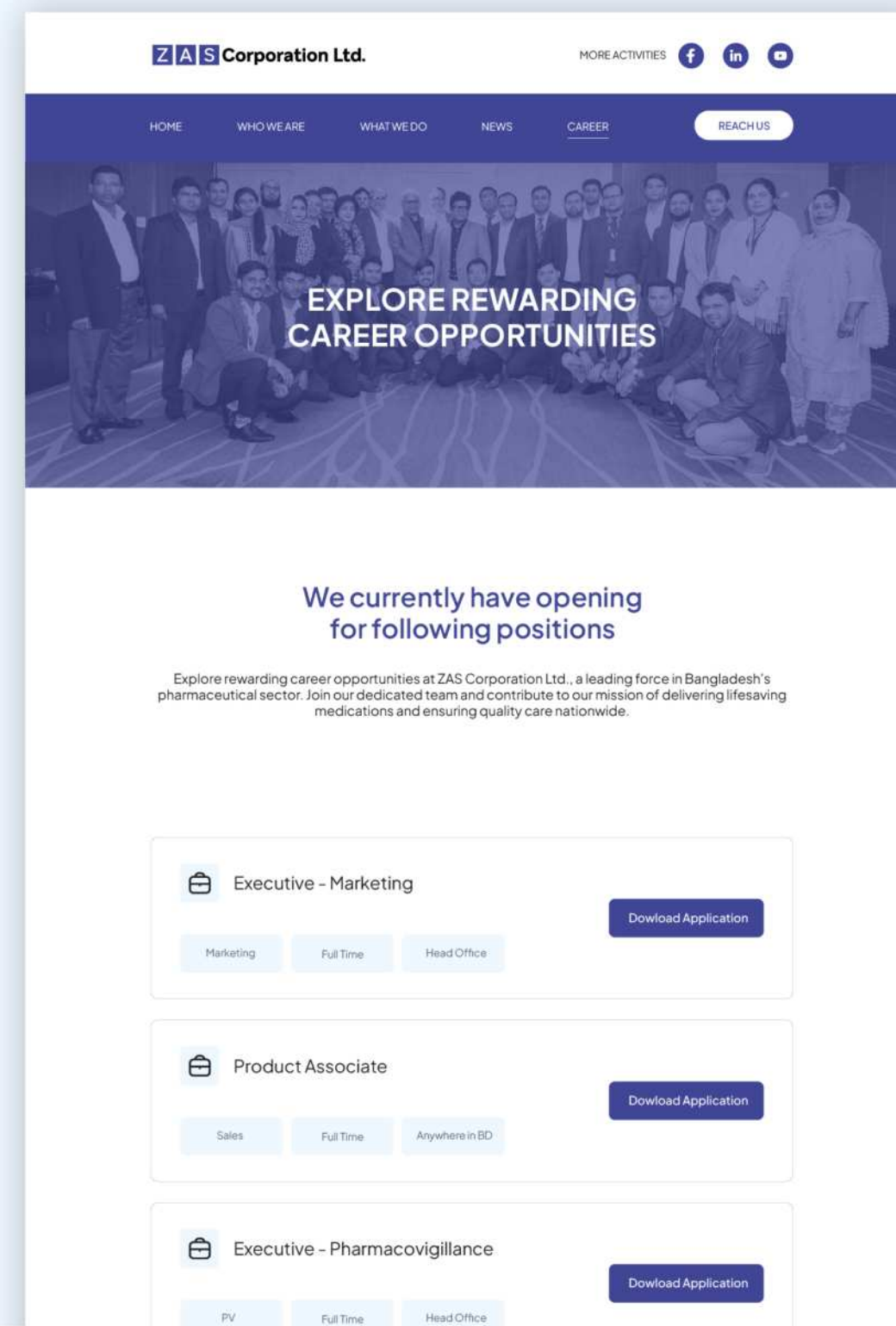
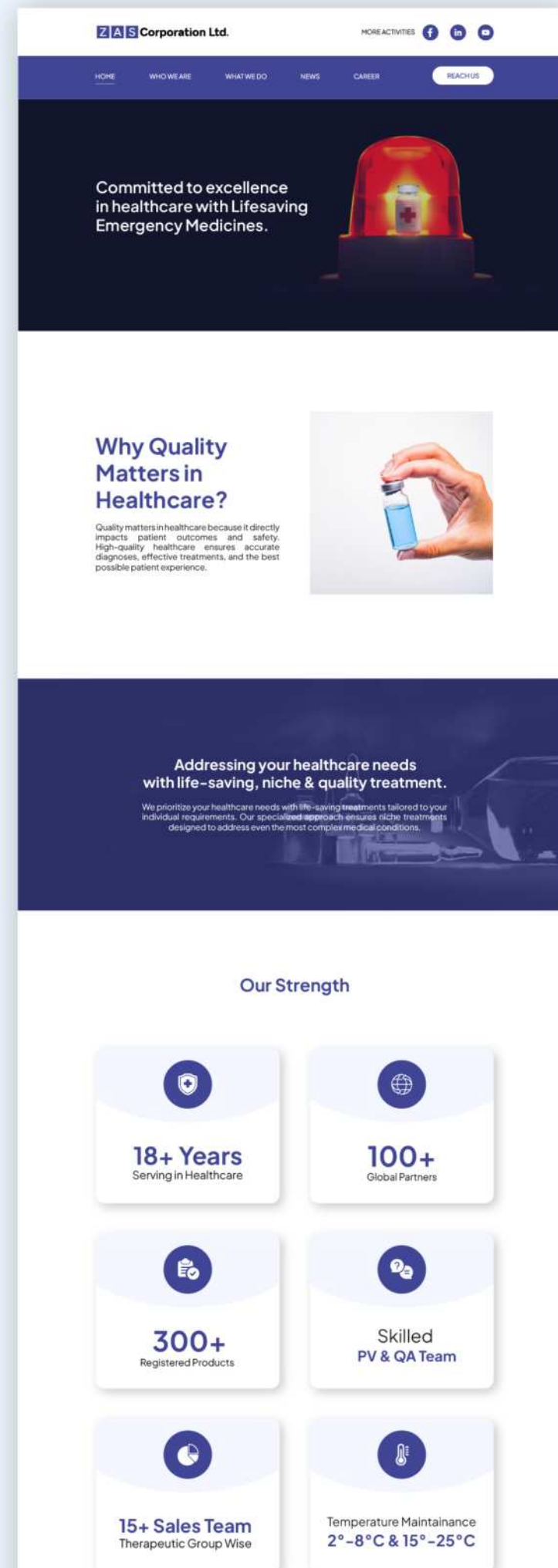



WEBSITE DESIGN

# FEATURED WORKS

TITLE: Website Design

CLIENT: ZAS Ophthalmic

PUBLISHED: 2024

DOMAIN: zasophthalmic.com

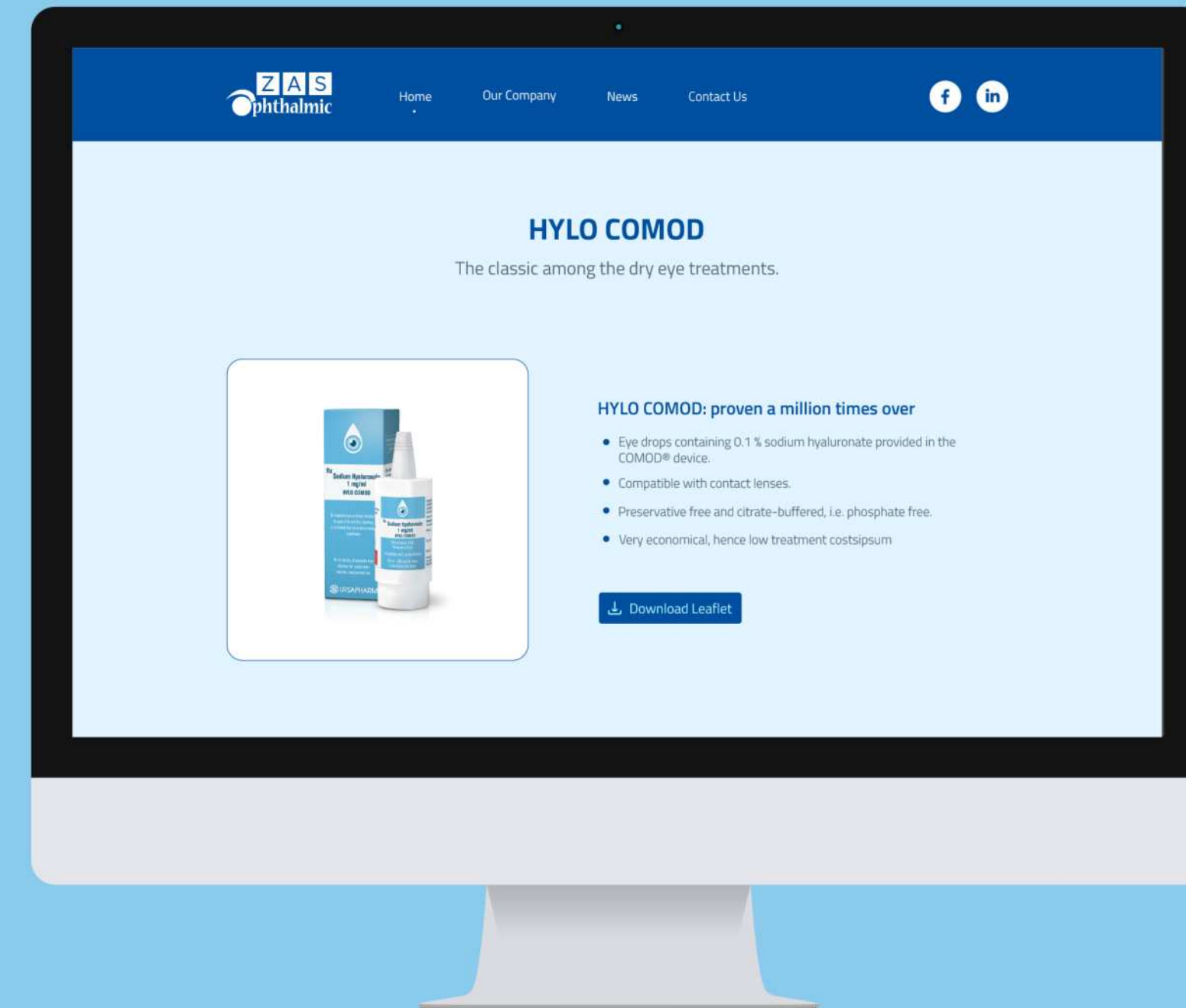
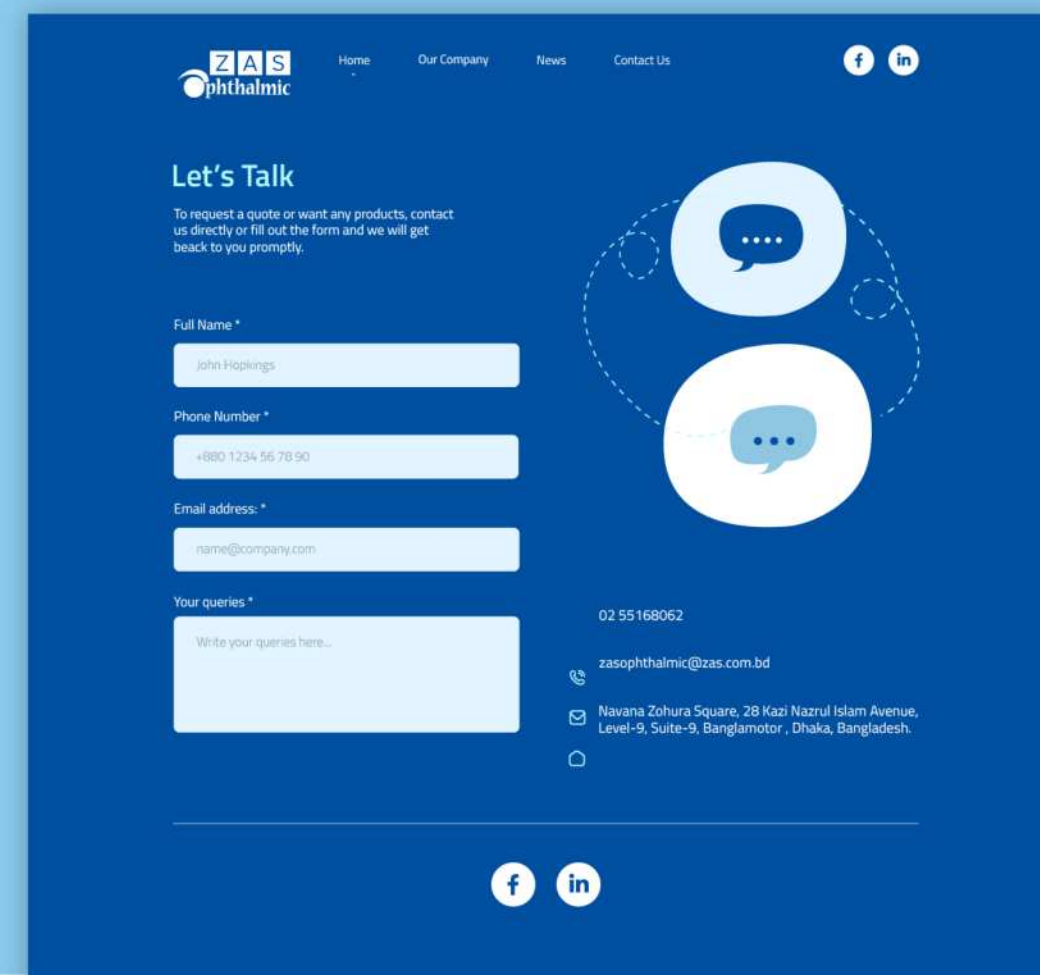
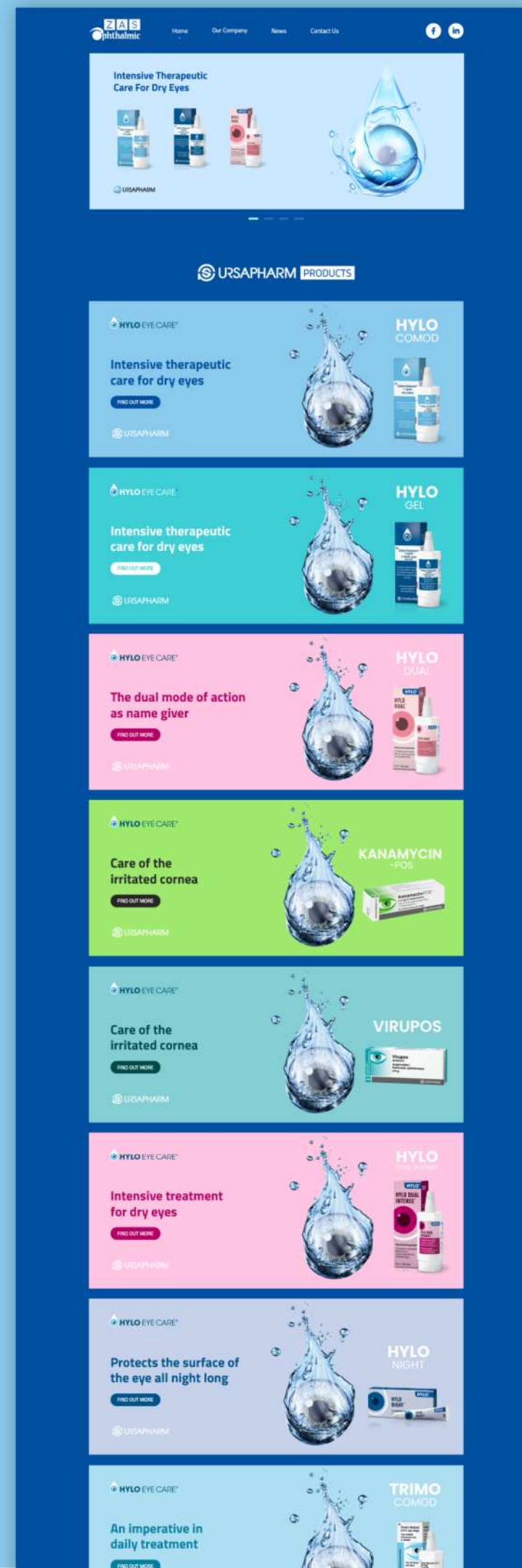



WEBSITE DESIGN

# FEATURED WORKS

TITLE: Website Design

CLIENT: ZAS Industries Ltd.

PUBLISHED: 2024

DOMAIN: www.zasindustries.com

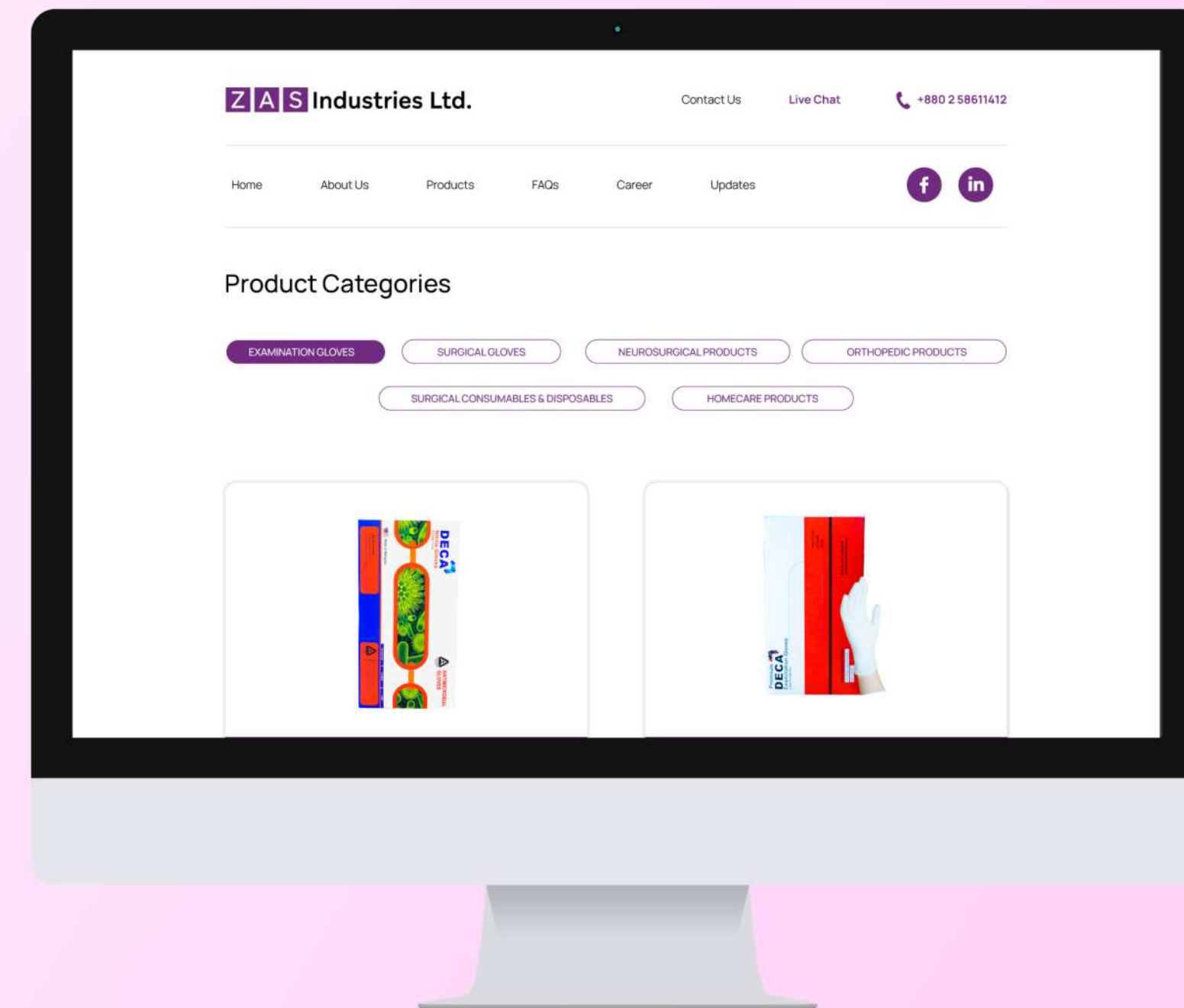
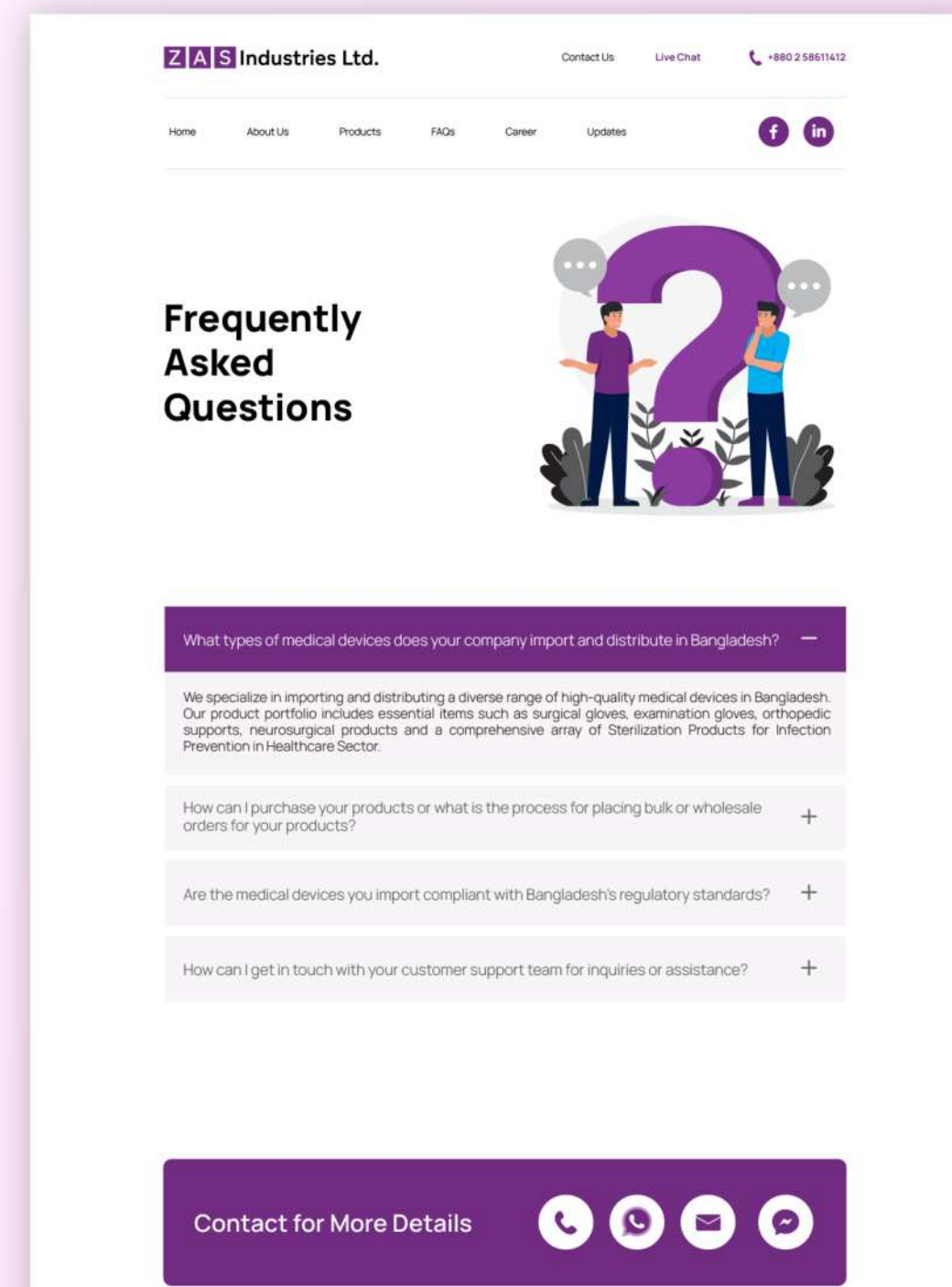
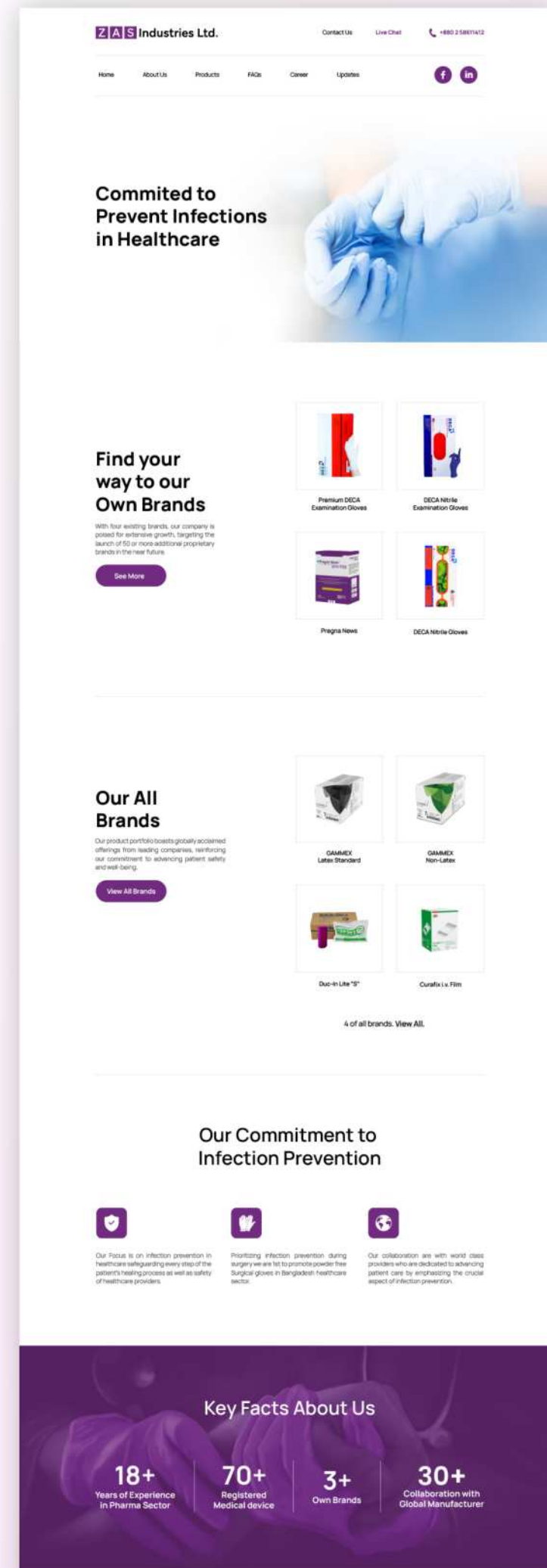

WEBSITE DESIGN

# FEATURED WORKS

TITLE: Website Design

CLIENT: ZAS Group

PUBLISHED: 2024

DOMAIN: www.zas.com.bd

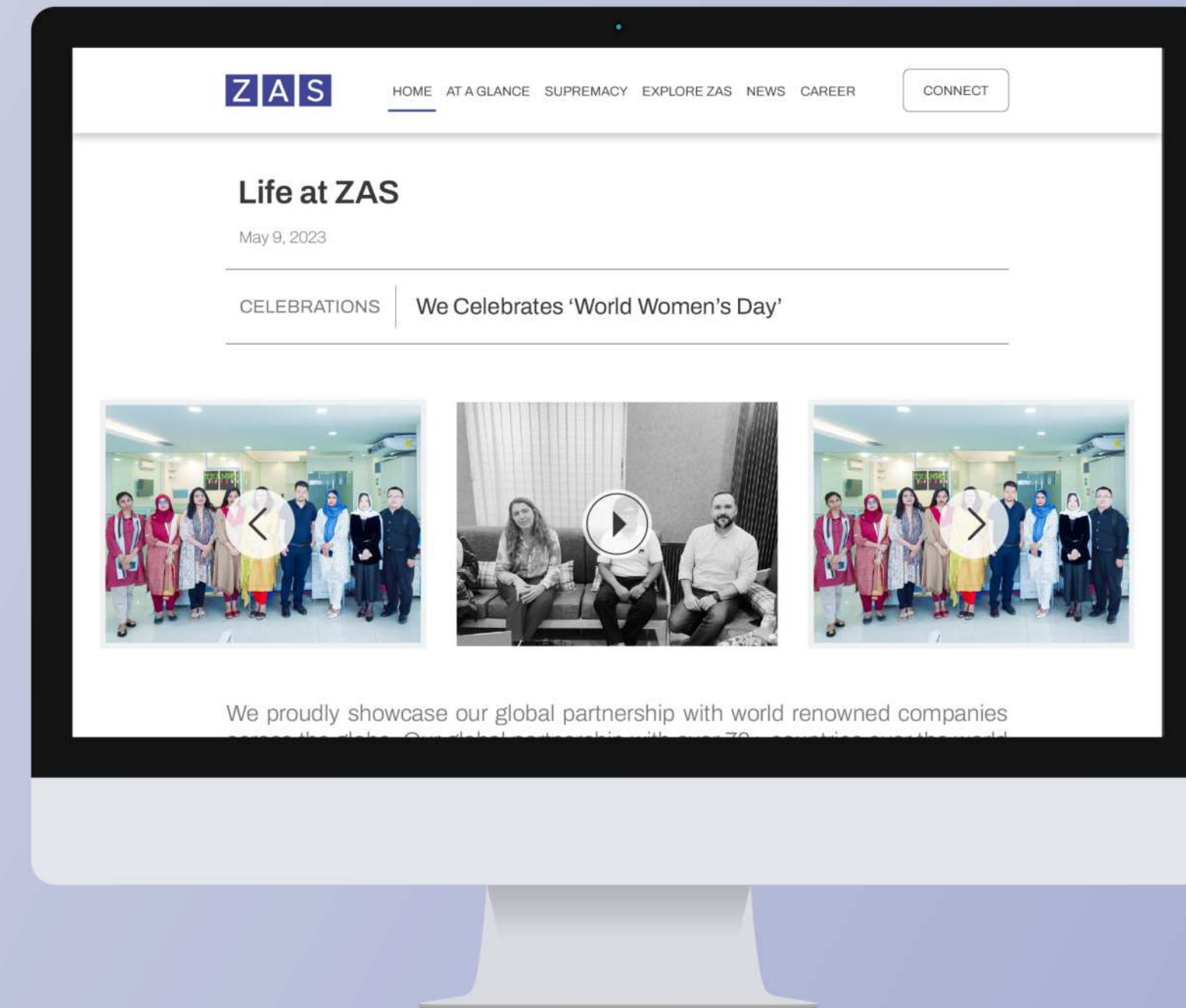
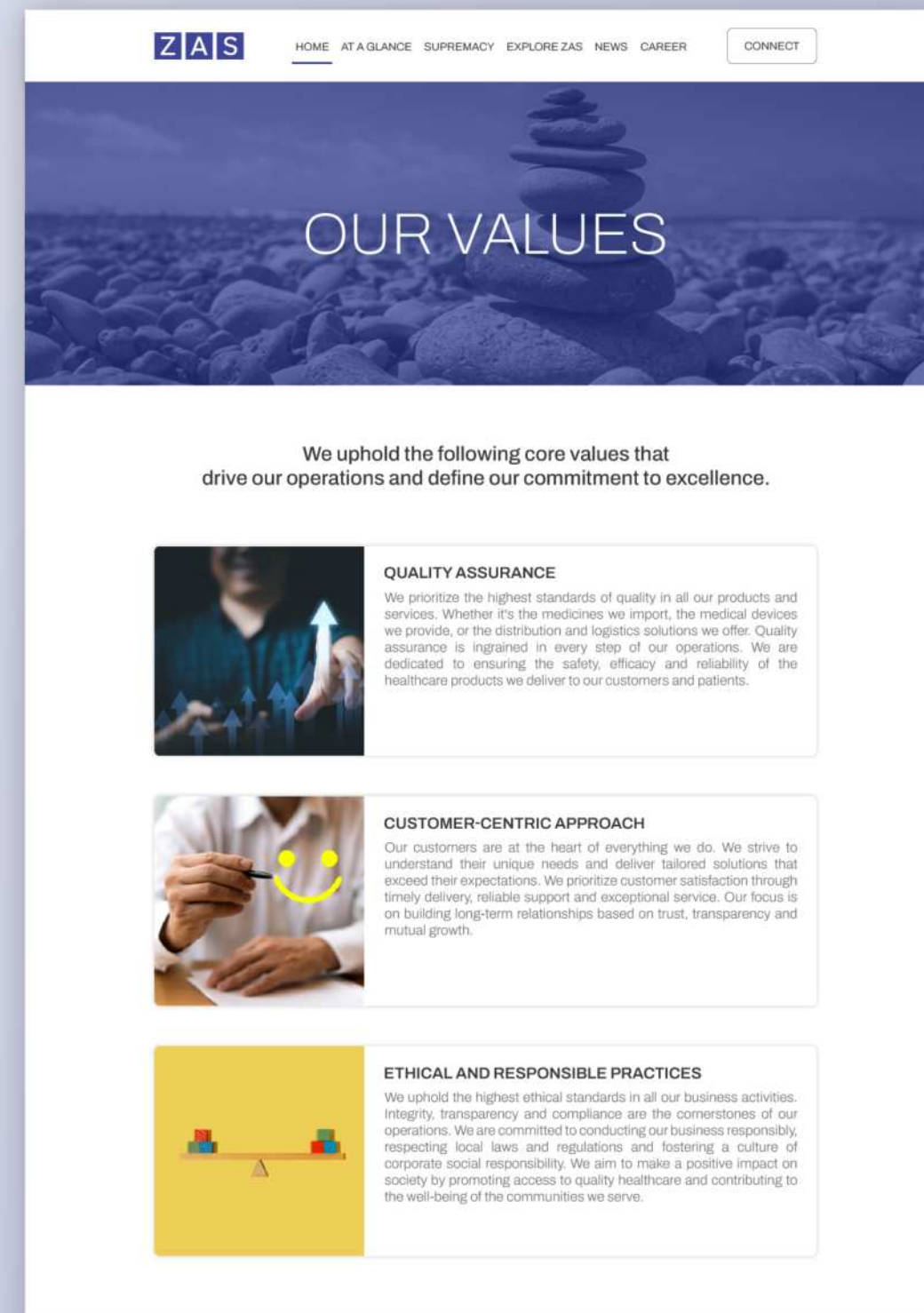
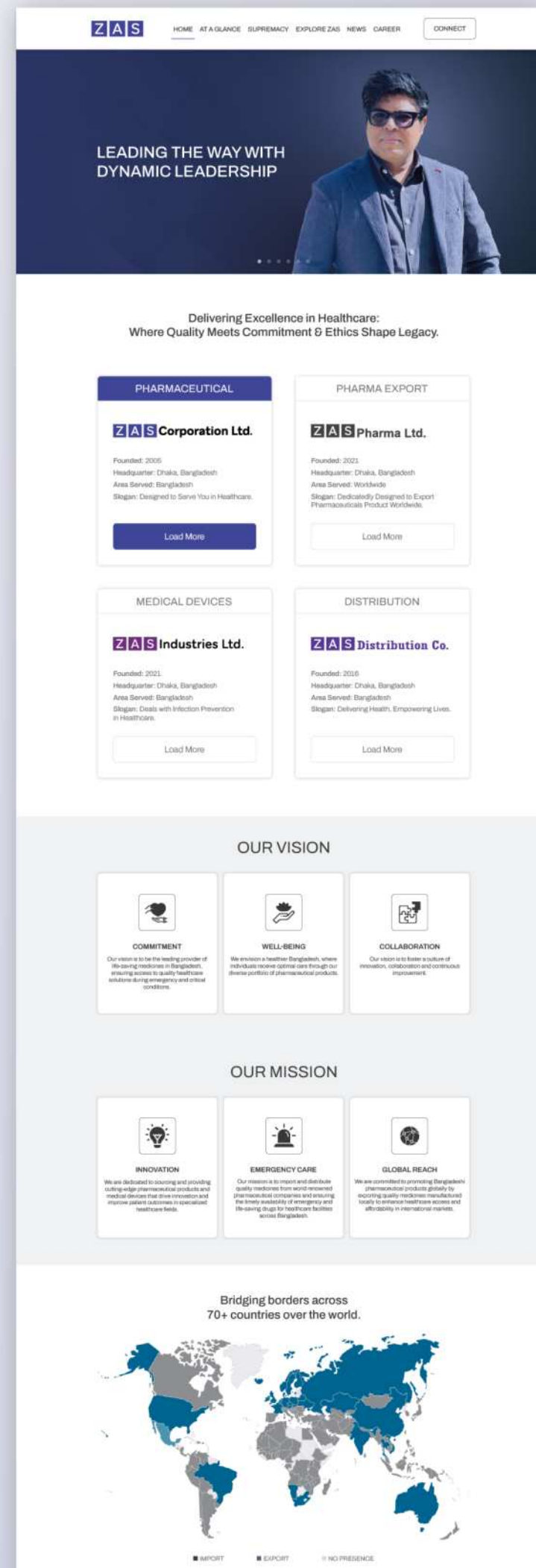



MOTION DESIGN

FEATURED WORKS

# Coming Soon...

Sorry, We are unable to provide an experience of Motion Design at this moment. Our team is working on it and hope we will get back soon with and excited update...

PHOTOGRAPHY

FEATURED WORKS

# Coming Soon...

Sorry, We are unable to provide an experience of Photography at this moment. Our team is working on it and hope we will get back soon with and excited update...



THANK YOU

ZAS comm.

+880 1897 60 57 36

hello@zascommunications.com

Nurjehan Tower, 80/22 Mymensingh Road,  
Banglamotor, Dhaka 1000

ENGAGE:



/zascommunications

